

ORIGINAL DESIGNED BY  
E. S. BALLANTYNE

# PILOT'S OPERATING HANDBOOK

The Cessna logo features the word "Cessna" in a serif font, with a stylized wing graphic above the letter "s".

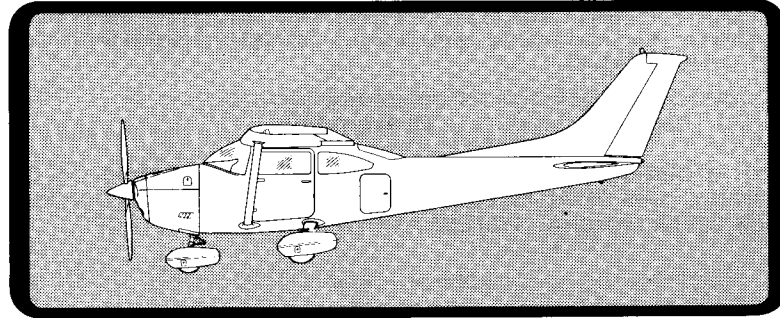

## SKYLANE

1976 MODEL 182P

Serial No. \_\_\_\_\_

Registration No. \_\_\_\_\_

THIS HANDBOOK INCLUDES THE MATERIAL  
REQUIRED TO BE FURNISHED TO THE PILOT  
BY CAR PART 3

CESSNA AIRCRAFT COMPANY  
WICHITA, KANSAS, USA

**LIST OF EFFECTIVE PAGES**      INSERT LATEST CHANGED PAGES: DISPOSE OF SUPERSEDED PAGES.

**NOTE:** This handbook will be kept current by Service Letters published by Cessna Aircraft Company. These are distributed to Cessna Dealers and to those who subscribe through the Owner Follow-Up System. If you are not receiving subscription service, you will want to keep in touch with your Cessna Dealer for information concerning the change status of the handbook. Subsequent changes should be examined immediately after receipt; the handbook should not be used for operational purposes until it has been updated to a current status. On a changed page, the portion of the text or illustration affected by the change is indicated by a vertical line in the outer margin of the page.

Dates of issue for original and changed pages are:  
Original . . . . 0 . . . . 29 August 1975

THE TOTAL NUMBER OF PAGES IN THIS HANDBOOK IS 258, CONSISTING OF THE FOLLOWING. THIS TOTAL INCLUDES THE SUPPLEMENTS PROVIDED IN SECTION 9 WHICH COVER OPTIONAL SYSTEMS AVAILABLE IN THE AIRPLANE.

Page No.	#Change No.	Page No.	#Change No.
Title . . . . .	0	5-28 Blank . . . . .	0
A . . . . .	0	6-1 . . . . .	0
i thru iii . . . . .	0	6-2 Blank . . . . .	0
iv Blank . . . . .	0	6-3 thru 6-13 . . . . .	0
1-1 thru 1-8 . . . . .	0	6-14 Blank . . . . .	0
2-1 . . . . .	0	6-15 thru 6-25 . . . . .	0
2-2 Blank . . . . .	0	6-26 Blank . . . . .	0
2-3 thru 2-11 . . . . .	0	7-1 thru 7-40 . . . . .	0
2-12 Blank . . . . .	0	8-1 . . . . .	0
3-1 thru 3-15 . . . . .	0	8-2 Blank . . . . .	0
3-16 Blank . . . . .	0	8-3 thru 8-14 . . . . .	0
4-1 thru 4-22 . . . . .	0	9-1 thru 9-2 . . . . .	0
5-1 . . . . .	0	Supplements (84 Pages) . . . . .	0
5-2 Blank . . . . .	0	(Refer to Section 9 Table of Contents for Optional Systems Supplements)	
5-3 thru 5-27 . . . . .	0		

# Zero in this column indicates an original page.

# CONGRATULATIONS . . . .

Welcome to the ranks of Cessna owners! Your Cessna has been designed and constructed to give you the most in performance, economy, and comfort. It is our desire that you will find flying it, either for business or pleasure, a pleasant and profitable experience.

This Pilot's Operating Handbook has been prepared as a guide to help you get the most pleasure and utility from your airplane. It contains information about your Cessna's equipment, operating procedures, and performance; and suggestions for its servicing and care. We urge you to read it from cover to cover, and to refer to it frequently.

Our interest in your flying pleasure has not ceased with your purchase of a Cessna. Worldwide, the Cessna Dealer Organization backed by the Cessna Customer Services Department stands ready to serve you. The following services are offered by most Cessna Dealers:

- THE CESSNA WARRANTY, which provides coverage for parts and labor, is available at Cessna Dealers worldwide. Specific benefits and provisions of warranty, plus other important benefits for you, are contained in your Customer Care Program book, supplied with your airplane. Warranty service is available to you at authorized Cessna Dealers throughout the world upon presentation of your Customer Care Card which establishes your eligibility under the warranty.
- FACTORY TRAINED PERSONNEL to provide you with courteous expert service.
- FACTORY APPROVED SERVICE EQUIPMENT to provide you efficient and accurate workmanship.
- A STOCK OF GENUINE CESSNA SERVICE PARTS on hand when you need them.
- THE LATEST AUTHORITATIVE INFORMATION FOR SERVICING CESSNA AIRPLANES, since Cessna Dealers have all of the Service Manuals and Parts Catalogs, kept current by Service Letters and Service News Letters, published by Cessna Aircraft Company.

We urge all Cessna owners to use the Cessna Dealer Organization to the fullest.

A current Cessna Dealer Directory accompanies your new airplane. The Directory is revised frequently, and a current copy can be obtained from your Cessna Dealer. Make your Directory one of your cross-country flight planning aids; a warm welcome awaits you at every Cessna Dealer.

## PERFORMANCE - SPECIFICATIONS

<b>SPEED:</b>	
Maximum at Sea Level . . . . .	148 KNOTS
Cruise, 75% Power at 6500 Ft . . . . .	144 KNOTS
<b>CRUISE: Recommended Lean Mixture with fuel allowance for engine start, taxi, takeoff, climb and 45 minutes reserve at 45% power.</b>	
75% Power at 6500 Ft . . . . .	Range 475 NM
56 Gallons Usable Fuel . . . . .	Time 3.4 HRS
75% Power at 6500 Ft . . . . .	Range 670 NM
75 Gallons Usable Fuel . . . . .	Time 4.7 HRS
Maximum Range at 10,000 Ft . . . . .	Range 565 NM
56 Gallons Usable Fuel . . . . .	Time 5.1 HRS
Maximum Range at 10,000 Ft . . . . .	Range 810 NM
75 Gallons Usable Fuel . . . . .	Time 7.3 HRS
<b>RATE OF CLIMB AT SEA LEVEL . . . . .</b>	<b>890 FPM</b>
<b>SERVICE CEILING . . . . .</b>	<b>17,700 FT</b>
<b>TAKEOFF PERFORMANCE:</b>	
Ground Roll . . . . .	705 FT
Total Distance Over 50-Ft Obstacle . . . . .	1350 FT
<b>LANDING PERFORMANCE:</b>	
Ground Roll . . . . .	590 FT
Total Distance Over 50-Ft Obstacle . . . . .	1350 FT
<b>STALL SPEED (CAS):</b>	
Flaps Up, Power Off . . . . .	56 KNOTS
Flaps Down, Power Off . . . . .	50 KNOTS
<b>MAXIMUM WEIGHT . . . . .</b>	<b>2950 LBS</b>
<b>STANDARD EMPTY WEIGHT:</b>	
Skylane . . . . .	1707 LBS
Skylane II . . . . .	1771 LBS
<b>MAXIMUM USEFUL LOAD:</b>	
Skylane . . . . .	1243 LBS
Skylane II . . . . .	1179 LBS
<b>BAGGAGE ALLOWANCE . . . . .</b>	<b>200 LBS</b>
<b>WING LOADING: Pounds/Sq Ft . . . . .</b>	<b>16.9</b>
<b>POWER LOADING: Pounds/HP . . . . .</b>	<b>12.8</b>
<b>FUEL CAPACITY: Total</b>	
Standard Tanks . . . . .	61 GAL.
Long Range Tanks . . . . .	80 GAL.
<b>OIL CAPACITY . . . . .</b>	<b>12 QTS</b>
<b>ENGINE: Teledyne Continental . . . . .</b>	<b>O-470-S</b>
230 BHP at 2600 RPM	
<b>PROPELLER: Constant Speed, Diameter . . . . .</b>	<b>82 IN.</b>

# TABLE OF CONTENTS

	SECTION
GENERAL . . . . .	1
LIMITATIONS . . . . .	2
EMERGENCY PROCEDURES . . . . .	3
NORMAL PROCEDURES . . . . .	4
PERFORMANCE . . . . .	5
WEIGHT & BALANCE/ EQUIPMENT LIST . . . . .	6
AIRPLANE & SYSTEMS DESCRIPTIONS . . . . .	7
AIRPLANE HANDLING, SERVICE & MAINTENANCE . . . . .	8
SUPPLEMENTS (Optional Systems Description & Operating Procedures) . . . . .	9



# SECTION 1 GENERAL

## TABLE OF CONTENTS

	Page
Three View . . . . .	1-2
Introduction . . . . .	1-3
Descriptive Data . . . . .	1-3
Engine . . . . .	1-3
Propeller . . . . .	1-3
Fuel . . . . .	1-3
Oil . . . . .	1-4
Maximum Certificated Weights . . . . .	1-5
Standard Airplane Weights . . . . .	1-5
Cabin and Entry Dimensions . . . . .	1-5
Baggage Space and Entry Dimensions . . . . .	1-5
Specific Loadings . . . . .	1-5
Symbols, Abbreviations and Terminology . . . . .	1-6
General Airspeed Terminology Symbols . . . . .	1-6
Meteorological Terminology . . . . .	1-6
Engine Power Terminology . . . . .	1-7
Airplane Performance and Flight Planning Terminology . . . . .	1-7
Weight and Balance Terminology . . . . .	1-7

SECTION 1  
GENERAL

CESSNA  
MODEL 182P

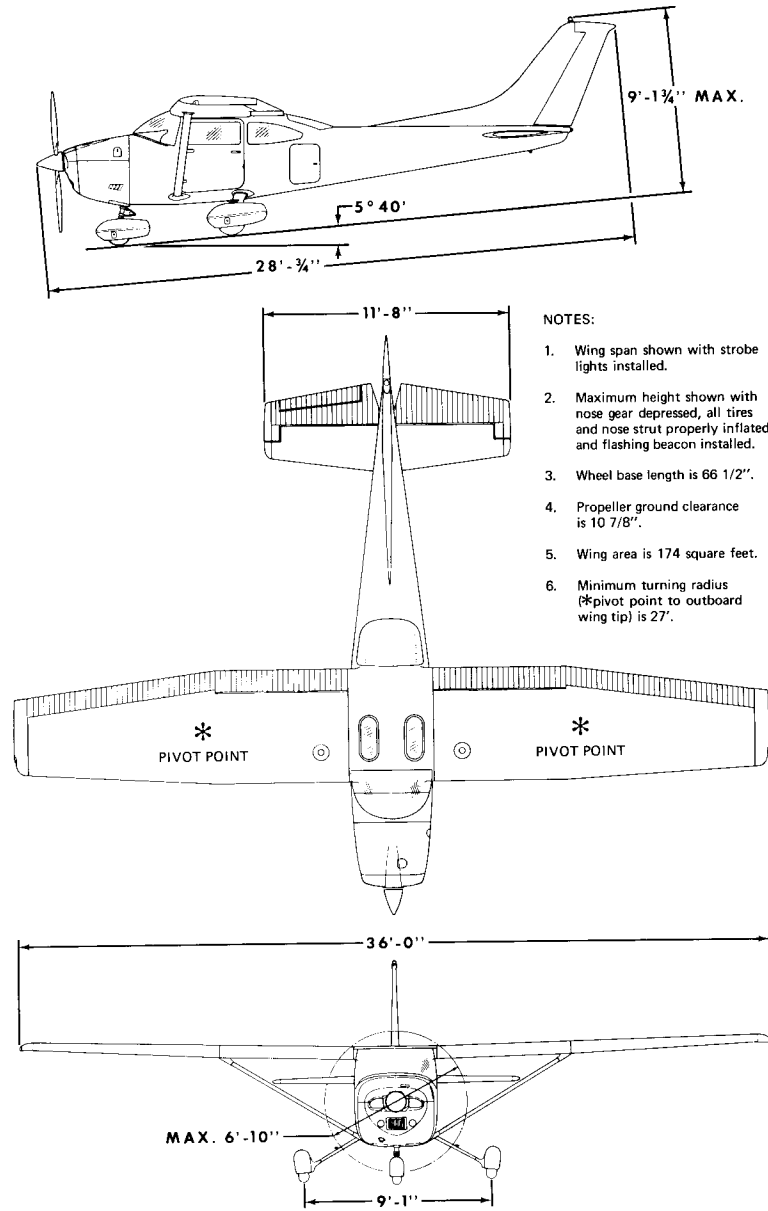

Figure 1-1. Three View



## INTRODUCTION

This handbook contains 9 sections, and includes the material required to be furnished to the pilot by CAR Part 3. It also contains supplemental data supplied by Cessna Aircraft Company.

Section 1 provides basic data and information of general interest. It also contains definitions or explanations of symbols, abbreviations, and terminology commonly used.

## DESCRIPTIVE DATA

### ENGINE

Number of Engines: 1.  
Engine Manufacturer: Teledyne Continental.  
Engine Model Number: O-470-S.  
Engine Type: Normally-aspirated, direct-drive, air-cooled, horizontally-opposed, carburetor-equipped, six-cylinder engine with 470 cu. in. displacement.  
Horsepower Rating and Engine Speed: 230 rated BHP at 2600 RPM.

### PROPELLER

Propeller Manufacturer: McCauley Accessory Division.  
Propeller Model Number: 2A34C203/90DCA-8.  
Number of Blades: 2.  
Propeller Diameter, Maximum: 82 inches.  
Minimum: 80.5 inches.  
Propeller Type: Constant speed and hydraulically actuated, with a low pitch setting of 12.5° and a high pitch setting of 25.0° (30 inch station).

### FUEL

Fuel Grade (and Color): 80/87 Minimum Grade Aviation Fuel (red).  
Alternate fuels which are also approved are:  
100/130 Low Lead AVGAS (blue). (Maximum lead content of 2 cc per gallon.)  
100/130 Aviation Grade Fuel (green). (Maximum lead content of 4.6 cc per gallon.)

#### NOTE

When substituting a higher octane fuel, low lead AVGAS

100 should be used whenever possible since it will result in less lead contamination of the engine.

Fuel Capacity:

Standard Tanks:

Total Capacity: 61 gallons.  
Total Capacity Each Tank: 30.5 gallons.  
Total Usable: 56 gallons.

Long Range Tanks:

Total Capacity: 80 gallons.  
Total Capacity Each Tank: 40 gallons.  
Total Usable: 75 gallons.

NOTE

To ensure maximum fuel capacity when refueling, place the fuel selector valve in either LEFT or RIGHT position to prevent cross-feeding.

OIL

Oil Grade (Specification):

MIL-L-6082 Aviation Grade Straight Mineral Oil: Use to replenish supply during first 25 hours and at the first 25-hour oil change. Continue to use until a total of 50 hours has accumulated or oil consumption has stabilized.

NOTE

The airplane was delivered from the factory with a corrosion preventive aircraft engine oil. This oil should be drained after the first 25 hours of operation.

Continental Motors Specification MHS-24A, Ashless Dispersant Oil:

This oil must be used after first 50 hours or oil consumption has stabilized.

Recommended Viscosity For Temperature Range:

SAE 50 above 4°C (40°F).  
SAE 10W30 or SAE 30 below 4°C (40°F).

NOTE

Multi-viscosity oil with a range of SAE 10W30 is recommended for improved starting in cold weather.

Oil Capacity:

Sump: 12 Quarts.  
Total: 13 Quarts (if oil filter installed).

### MAXIMUM CERTIFICATED WEIGHTS

Takeoff: 2950 lbs.

Landing: 2950 lbs.

Weight in Baggage Compartment:

Baggage Area "A" (or passenger on child's seat)-Station 82 to 108:  
120 lbs. See note below.

Baggage Area "B" and Hatshelf-Station 108 to 136: 80 lbs. See  
note below.

#### NOTE

The maximum combined weight capacity for baggage areas A and B, including the hatshelf, is 200 lbs. The maximum hatshelf load is 25 lbs.

### STANDARD AIRPLANE WEIGHTS

Standard Empty Weight, Skylane: 1707 lbs.

Skylane II: 1771 lbs.

Maximum Useful Load, Skylane: 1243 lbs.

Skylane II: 1179 lbs.

### CABIN AND ENTRY DIMENSIONS

Detailed dimensions of the cabin interior and entry door openings are illustrated in Section 6.

### BAGGAGE SPACE AND ENTRY DIMENSIONS

Dimensions of the baggage area and baggage door opening are illustrated in detail in Section 6.

### SPECIFIC LOADINGS

Wing Loading: 16.9 lbs./sq. ft.

Power Loading: 12.8 lbs./hp.

## SYMBOLS, ABBREVIATIONS AND TERMINOLOGY

### GENERAL AIRSPEED TERMINOLOGY AND SYMBOLS

KCAS	<u>Knots Calibrated Airspeed</u> is indicated airspeed corrected for position and instrument error and expressed in knots. Knots calibrated airspeed is equal to KTAS in standard atmosphere at sea level.
KIAS	<u>Knots Indicated Airspeed</u> is the speed shown on the airspeed indicator and expressed in knots.
KTAS	<u>Knots True Airspeed</u> is the airspeed expressed in knots relative to undisturbed air which is KCAS corrected for altitude and temperature.
$V_A$	<u>Maneuvering Speed</u> is the maximum speed at which you may use abrupt control travel.
$V_{FE}$	<u>Maximum Flap Extended Speed</u> is the highest speed permissible with wing flaps in a prescribed extended position.
$V_{NO}$	<u>Maximum Structural Cruising Speed</u> is the speed that should not be exceeded except in smooth air, then only with caution.
$V_{NE}$	<u>Never Exceed Speed</u> is the speed limit that may not be exceeded at any time.
$V_S$	<u>Stalling Speed or the minimum steady flight speed</u> at which the airplane is controllable.
$V_{S_0}$	<u>Stalling Speed or the minimum steady flight speed</u> at which the airplane is controllable in the landing configuration at the most forward center of gravity.
$V_X$	<u>Best Angle-of-Climb Speed</u> is the speed which results in the greatest gain of altitude in a given horizontal distance.
$V_Y$	<u>Best Rate-of-Climb Speed</u> is the speed which results in the greatest gain in altitude in a given time.

### METEOROLOGICAL TERMINOLOGY

OAT	<u>Outside Air Temperature</u> is the free air static temperature. It is expressed in either degrees Celsius (formerly Centigrade) or degrees Fahrenheit.
-----	---

Standard Temperature     Standard Temperature is 15°C at sea level pressure altitude and decreases by 2°C for each 1000 feet of altitude.

Pressure Altitude     Pressure Altitude is the altitude read from an altimeter when the barometric subscale has been set to 29.92 inches of mercury (1013 mb).

#### ENGINE POWER TERMINOLOGY

BHP     Brake Horsepower is the power developed by the engine.

RPM     Revolutions Per Minute is engine speed.

MP     Manifold Pressure is a pressure measured in the engine's induction system and is expressed in inches of mercury (Hg).

#### AIRPLANE PERFORMANCE AND FLIGHT PLANNING TERMINOLOGY

Demonstrated Crosswind Velocity     Demonstrated Crosswind Velocity is the velocity of the crosswind component for which adequate control of the airplane during takeoff and landing was actually demonstrated during certification tests. The value shown is not considered to be limiting.

Usable Fuel     Usable Fuel is the fuel available for flight planning.

Unusable Fuel     Unusable Fuel is the quantity of fuel that can not be safely used in flight.

GPH     Gallons Per Hour is the amount of fuel (in gallons) consumed per hour.

NMPG     Nautical Miles Per Gallon is the distance (in nautical miles) which can be expected per gallon of fuel consumed at a specific engine power setting and/or flight configuration.

g     g is acceleration due to gravity.

#### WEIGHT AND BALANCE TERMINOLOGY

Reference Datum     Reference Datum is an imaginary vertical plane from which all horizontal distances are measured for balance purposes.

Station     Station is a location along the airplane fuselage given in terms of the distance from the reference datum.

Arm	<u>Arm</u> is the horizontal distance from the reference datum to the center of gravity (C.G.) of an item.
Moment	<u>Moment</u> is the product of the weight of an item multiplied by its arm. (Moment divided by the constant 1000 is used in this handbook to simplify balance calculations by reducing the number of digits.)
Center of Gravity (C.G.)	<u>Center of Gravity</u> is the point at which an airplane, or equipment, would balance if suspended. Its distance from the reference datum is found by dividing the total moment by the total weight of the airplane.
C.G. Arm	<u>Center of Gravity Arm</u> is the arm obtained by adding the airplane's individual moments and dividing the sum by the total weight.
C.G. Limits	<u>Center of Gravity Limits</u> are the extreme center of gravity locations within which the airplane must be operated at a given weight.
Standard Empty Weight	<u>Standard Empty Weight</u> is the weight of a standard airplane, including unusable fuel, full operating fluids and full engine oil.
Basic Empty Weight	<u>Basic Empty Weight</u> is the standard empty weight plus the weight of optional equipment.
Useful Load	<u>Useful Load</u> is the difference between takeoff weight and the basic empty weight.
Gross (Loaded) Weight	<u>Gross (Loaded) Weight</u> is the loaded weight of the airplane.
Maximum Takeoff Weight	<u>Maximum Takeoff Weight</u> is the maximum weight approved for the start of the takeoff run.
Maximum Landing Weight	<u>Maximum Landing Weight</u> is the maximum weight approved for the landing touchdown.
Tare	<u>Tare</u> is the weight of chocks, blocks, stands, etc. used when weighing an airplane, and is included in the scale readings. Tare is deducted from the scale reading to obtain the actual (net) airplane weight.

# SECTION 2 LIMITATIONS

## TABLE OF CONTENTS

	Page
Introduction . . . . .	2-3
Airspeed Limitations . . . . .	2-4
Airspeed Indicator Markings . . . . .	2-4
Power Plant Limitations . . . . .	2-5
Power Plant Instrument Markings . . . . .	2-6
Weight Limits . . . . .	2-6
Center of Gravity Limits . . . . .	2-7
Maneuver Limits . . . . .	2-7
Flight Load Factor Limits . . . . .	2-7
Kinds of Operation Limits . . . . .	2-7
Fuel Limitations . . . . .	2-8
Placards . . . . .	2-9





## INTRODUCTION

Section 2 includes operating limitations, instrument markings, and basic placards necessary for the safe operation of the airplane, its engine, standard systems and standard equipment. The limitations included in this section have been approved by the Federal Aviation Administration. When applicable, limitations associated with optional systems or equipment are included in Section 9.

### NOTE

The airspeeds listed in the Airspeed Limitations chart (figure 2-1) and the Airspeed Indicator Markings chart (figure 2-2) are based on Airspeed Calibration data shown in Section 5 with the normal static source. If the alternate static source is being used, ample margins should be observed to allow for the airspeed calibration variations between the normal and alternate static sources as shown in Section 5.

Your Cessna is certificated under FAA Type Certificate No. 3A13 as Cessna Model No. 182P.

## AIRSPPEED LIMITATIONS

Airspeed limitations and their operational significance are shown in figure 2-1.

	SPEED	KCAS	KIAS	REMARKS
V <sub>NE</sub>	Never Exceed Speed	172	176	Do not exceed this speed in any operation.
V <sub>NO</sub>	Maximum Structural Cruising Speed	139	141	Do not exceed this speed except in smooth air, and then only with caution.
V <sub>A</sub>	Maneuvering Speed: 2950 Pounds 2450 Pounds 1950 Pounds	109 99 89	110 100 89	Do not make full or abrupt control movements above this speed.
V <sub>FE</sub>	Maximum Flap Extended Speed: To 10° Flaps 10° - 40° Flaps	138 95	140 95	Do not exceed these speeds with the given flap settings.
	Maximum Window Open Speed	172	176	Do not exceed this speed with windows open.

Figure 2-1. Airspeed Limitations

## AIRSPPEED INDICATOR MARKINGS

Airspeed indicator markings and their color code significance are shown in figure 2-2.

MARKING	KIAS VALUE OR RANGE	SIGNIFICANCE
White Arc	48 - 95	Full Flap Operating Range. Lower limit is maximum weight $V_{S0}$ in landing configuration. Upper limit is maximum speed permissible with flaps extended.
Green Arc	53 - 141	Normal Operating Range. Lower limit is maximum weight $V_S$ with flaps retracted. Upper limit is maximum structural cruising speed.
Yellow Arc	141 - 176	Operations must be conducted with caution and only in smooth air.
Red Line	176	Maximum speed for all operations.

Figure 2-2. Airspeed Indicator Markings

## POWER PLANT LIMITATIONS

Engine Manufacturer: Teledyne Continental.

Engine Model Number: O-470-S.

Engine Operating Limits for Takeoff and Continuous Operations:

Maximum Power: 230 BHP.

Maximum Engine Speed: 2600 RPM.

Maximum Cylinder Head Temperature: 238°C (460°F).

Maximum Oil Temperature: 116°C (240°F).

Oil Pressure, Minimum: 10 psi.

Maximum: 100 psi.

Propeller Manufacturer: McCauley Accessory Division.

Propeller Model Number: 2A34C203/90DCA-8.

Propeller Diameter, Maximum: 82 inches.

Minimum: 80.5 inches.

Propeller Blade Angle at 30 Inch Station, Low: 12.5°.

High: 25.0°.

## POWER PLANT INSTRUMENT MARKINGS

Power plant instrument markings and their color code significance are shown in figure 2-3.

INSTRUMENT	RED LINE	GREEN ARC	YELLOW ARC	RED LINE
	MINIMUM LIMIT	NORMAL OPERATING	CAUTION RANGE	MAXIMUM LIMIT
Tachometer	---	2200 - 2450 RPM	---	2600 RPM
Manifold Pressure	---	15-23 in. Hg	---	---
Oil Temperature	---	100° - 240°F	---	240°F
Cylinder Head Temperature	---	200° - 460°F	---	460°F
Oil Pressure	10 psi	30-60 psi	---	100 psi
Carburetor Air Temperature	---	---	-15° to 5°C	---

Figure 2-3. Power Plant Instrument Markings

## WEIGHT LIMITS

Maximum Takeoff Weight: 2950 lbs.

Maximum Landing Weight: 2950 lbs.

Maximum Weight in Baggage Compartment:

Baggage Area "A" (or passenger on child's seat) -

Station 82 to 108: 120 lbs. See note below.

Baggage Area "B" and Hatshelf -

Station 108 to 136: 80 lbs. See note below.

### NOTE

The maximum combined weight capacity for baggage areas A and B, including the hatshelf, is 200 lbs. The maximum hatshelf load is 25 lbs.

## CENTER OF GRAVITY LIMITS

### Center of Gravity Range:

Forward: 33.0 inches aft of datum at 2250 lbs. or less, with straight line variation to 39.5 inches aft of datum at 2950 lbs.

Aft: 48.5 inches aft of datum at all weights.

Reference Datum: Front face of firewall.

## MANEUVER LIMITS

This airplane is certificated in the normal category. The normal category is applicable to aircraft intended for non-aerobatic operations. These include any maneuvers incidental to normal flying, stalls (except whip stalls), lazy eights, chandelles, and steep turns in which the angle of bank is not more than 60°.

Aerobatic maneuvers, including spins, are not approved.

## FLIGHT LOAD FACTOR LIMITS

### Flight Load Factors

\*Flaps Up: +3.8g, -1.52g

\*Flaps Down: +2.0g

\*The design load factors are 150% of the above, and in all cases, the structure meets or exceeds design loads.

## KINDS OF OPERATION LIMITS

The airplane is equipped for day VFR and may be equipped for night VFR and/or IFR operations. FAR Part 91 establishes the minimum required instrumentation and equipment for these operations. The reference to types of flight operations on the operating limitations placard reflects equipment installed at the time of Airworthiness Certificate issuance.

Flight into known icing conditions is prohibited.

## FUEL LIMITATIONS

- 2 Standard Tanks: 30.5 U.S. gallons each.  
Total Fuel: 61 U.S. gallons.  
Usable Fuel (all flight conditions): 56 U.S. gallons.  
Unusable Fuel: 5.0 U.S. gallons.
- 2 Long Range Tanks: 40 U.S. gallons each.  
Total Fuel: 80 U.S. gallons.  
Usable Fuel (all flight conditions): 75 U.S. gallons.  
Unusable Fuel: 5.0 U.S. gallons.

### NOTE

To ensure maximum fuel capacity when refueling, place the fuel selector valve in either LEFT or RIGHT position to prevent cross-feeding.

### NOTE

Takeoff and land with the fuel selector valve handle in the BOTH position.

- Fuel Grade (and Color): 80/87 Minimum Grade Aviation Fuel (red).  
Alternate fuels which are also approved are:  
100/130 Low Lead AVGAS (blue). (Maximum lead content of 2 cc per gallon.)  
100/130 Aviation Grade Fuel (green). (Maximum lead content of 4.6 cc per gallon.)

### NOTE

When substituting a higher octane fuel, low lead AVGAS 100 should be used whenever possible since it will result in less lead contamination of the engine.

## PLACARDS

The following information is displayed in the form of composite or individual placards.

(1) In full view of the pilot: (The "DAY-NIGHT-VFR-IFR" entry, shown on the example below, will vary as the airplane is equipped.)

This airplane must be operated as a normal category airplane in compliance with the operating limitations as stated in the form of placards, markings, and manuals.		
————— MAXIMUMS —————		
MANEUVERING SPEED (IAS) . . . . .	110 knots	
GROSS WEIGHT . . . . .	2950 lbs.	
FLIGHT LOAD FACTOR . . . Flaps Up . . .	+3.8, -1.52	
	Flaps Down . . .	+2.0
No acrobatic maneuvers, including spins, approved. Altitude loss in a stall recovery - 160 ft. Flight into known icing conditions prohibited. This airplane is certified for the following flight operations as of date of original airworthiness certificate: DAY - NIGHT - VFR - IFR		

(2) On control lock:

Control lock - remove before starting engine.
---

(3) On the fuel selector valve plate (standard tanks):

Off Left - 29 gal. Level flight only. Both - 56 gal. All flight attitudes. Both on for takeoff and landing. Right - 29 gal. Level flight only.
---

On the fuel selector valve plate (long range tanks):

Off  
Left - 37 gal. Level flight only.  
Both - 75 gal. All flight attitudes. Both on for  
takeoff and landing.  
Right - 37 gal. Level flight only.

(4) On the baggage door:

FORWARD OF BAGGAGE DOOR LATCH  
120 POUNDS MAXIMUM  
BAGGAGE AND/OR AUXILIARY PASSENGER  
  
AFT OF BAGGAGE DOOR LATCH  
80 POUNDS MAXIMUM  
BAGGAGE INCLUDING 25 LBS MAXIMUM IN  
BAGGAGE WALL HATSHELF  
  
MAXIMUM 200 POUNDS COMBINED  
FOR ADDITIONAL LOADING INSTRUCTIONS SEE  
WEIGHT AND BALANCE DATA

(5) On flap control indicator:

0° to 20° - T.O.	(Takeoff range with blue color code and 140 kt callout; also, mechanical detent at 10°.)
10° to 20° - FULL	(Indices at these positions with white color code and 95 kt callout; also, mechanical detent at 10° and 20°.)

(6) Forward of fuel tank filler cap (standard tanks):

Service this airplane with 80/87 minimum aviation grade gasoline. Capacity 30.5 gal.



Forward of fuel tank filler cap (long range tanks):

Service this airplane with 80/87 minimum aviation grade gasoline. Capacity 40.0 gal.

(7) On aft panel of baggage compartment (all models with oxygen):

OXYGEN REFILL

(8) Adjacent to over-voltage light:

HIGH VOLTAGE



# SECTION 3

## EMERGENCY PROCEDURES

### TABLE OF CONTENTS

	Page
Introduction . . . . .	3-3
Airspeeds For Emergency Operation . . . . .	3-3
<b>OPERATIONAL CHECKLISTS</b>	
Engine Failures . . . . .	3-3
Engine Failure During Takeoff Run . . . . .	3-3
Engine Failure Immediately After Takeoff . . . . .	3-4
Engine Failure During Flight . . . . .	3-4
Forced Landings . . . . .	3-4
Emergency Landings Without Engine Power . . . . .	3-4
Precautionary Landing With Engine Power . . . . .	3-4
Ditching . . . . .	3-5
Fires . . . . .	3-5
During Start On Ground . . . . .	3-5
Engine Fire In Flight . . . . .	3-6
Electrical Fire In Flight . . . . .	3-6
Cabin Fire . . . . .	3-6
Wing Fire . . . . .	3-7
Icing . . . . .	3-7
Inadvertent Icing Encounter . . . . .	3-7
Static Source Blockage (Erroneous Instrument Reading Suspected) . . . . .	3-8
Landing With a Flat Main Tire . . . . .	3-8
Electrical Power Supply System Malfunctions . . . . .	3-8
Over-Voltage Light Illuminates. . . . .	3-8
Ammeter Shows Discharge. . . . .	3-8
<b>AMPLIFIED PROCEDURES</b>	
Engine Failure . . . . .	3-9
Forced Landings . . . . .	3-10
	3-1

**TABLE OF CONTENTS (Continued)**

	Page
Landing Without Elevator Control . . . . .	3-10
Fires . . . . .	3-10
Emergency Operation In Clouds (Vacuum System Failure). . . . .	3-10
Executing A 180° Turn In Clouds . . . . .	3-11
Emergency Descent Through Clouds . . . . .	3-11
Recovery From a Spiral Dive . . . . .	3-12
Flight In Icing Conditions . . . . .	3-12
Static Source Blocked . . . . .	3-12
Spins . . . . .	3-13
Rough Engine Operation Or Loss Of Power . . . . .	3-13
Carburetor Icing . . . . .	3-13
Spark Plug Fouling . . . . .	3-14
Magnetos Malfunction . . . . .	3-14
Low Oil Pressure . . . . .	3-14
Electrical Power Supply System Malfunctions . . . . .	3-15
Excessive Rate Of Charge . . . . .	3-15
Insufficient Rate Of Charge . . . . .	3-15

## INTRODUCTION

Section 3 provides checklist and amplified procedures for coping with emergencies that may occur. Emergencies caused by airplane or engine malfunctions are extremely rare if proper preflight inspections and maintenance are practiced. Enroute weather emergencies can be minimized or eliminated by careful flight planning and good judgement when unexpected weather is encountered. However, should an emergency arise the basic guidelines described in this section should be considered and applied as necessary to correct the problem. Emergency procedures associated with the ELT and other optional systems can be found in Section 9.

## AIRSPEEDS FOR EMERGENCY OPERATION

Engine Failure After Takeoff:	
Wing Flaps Up . . . . .	70 KIAS
Wing Flaps Down . . . . .	65 KIAS
Maneuvering Speed:	
2950 Lbs . . . . .	110 KIAS
2450 Lbs . . . . .	100 KIAS
1950 Lbs . . . . .	89 KIAS
Maximum Glide:	
2950 Lbs . . . . .	70 KIAS
Precautionary Landing With Engine Power . . . . .	65 KIAS
Landing Without Engine Power:	
Wing Flaps Up . . . . .	70 KIAS
Wing Flaps Down . . . . .	65 KIAS

## OPERATIONAL CHECKLISTS

### ENGINE FAILURES

#### ENGINE FAILURE DURING TAKEOFF RUN

- (1) Throttle -- IDLE.
- (2) Brakes -- APPLY.
- (3) Wing Flaps -- RETRACT.
- (4) Mixture -- IDLE CUT-OFF.
- (5) Ignition Switch -- OFF.

### ENGINE FAILURE IMMEDIATELY AFTER TAKEOFF

- (1) Airspeed -- 70 KIAS (flaps UP).  
65 KIAS (flaps DOWN).
- (2) Mixture -- IDLE CUT-OFF.
- (3) Fuel Selector Valve -- OFF.
- (4) Ignition Switch -- OFF.
- (5) Wing Flaps -- AS REQUIRED (40° recommended).
- (6) Master Switch -- OFF.

### ENGINE FAILURE DURING FLIGHT

- (1) Airspeed -- 70 KIAS.
- (2) Carburetor Heat -- ON.
- (3) Fuel Selector Valve -- BOTH.
- (4) Mixture -- RICH.
- (5) Ignition Switch -- BOTH (or START if propeller is stopped).
- (6) Primer -- IN and LOCKED.

## FORCED LANDINGS

### EMERGENCY LANDING WITHOUT ENGINE POWER

- (1) Airspeed -- 70 KIAS (flaps UP).  
65 KIAS (flaps DOWN).
- (2) Mixture -- IDLE CUT-OFF.
- (3) Fuel Selector Valve -- OFF.
- (4) Ignition Switch -- OFF.
- (5) Wing Flaps -- AS REQUIRED (40° recommended).
- (6) Master Switch -- OFF.
- (7) Doors -- UNLATCH PRIOR TO TOUCHDOWN.
- (8) Touchdown -- SLIGHTLY TAIL LOW.
- (9) Brakes -- APPLY HEAVILY.

### PRECAUTIONARY LANDING WITH ENGINE POWER

- (1) Wing Flaps -- 20°.
- (2) Airspeed -- 65 KIAS.
- (3) Selected Field -- FLY OVER, noting terrain and obstructions,  
then retract flaps upon reaching a safe altitude and airspeed.
- ~~(4)~~ Radio and Electrical Switches -- OFF.
- ~~(5)~~ Wing Flaps -- 40° (on final approach).
- (6) Airspeed -- 65 KIAS.
- (7) Master Switch -- OFF.

- (8) Doors -- UNLATCH PRIOR TO TOUCHDOWN.
- (9) Touchdown -- SLIGHTLY TAIL LOW.
- (10) Ignition Switch -- OFF.
- (11) Brakes -- APPLY HEAVILY.

### DITCHING

- (1) Radio -- TRANSMIT MAYDAY on 121.5 MHz, giving location and intentions.
- (2) Heavy Objects (in baggage area) -- SECURE OR JETTISON.
- (3) Flaps -- 20° - 40°.
- (4) Power -- ESTABLISH 300 FT/MIN DESCENT at 60 KIAS.
- (5) Approach -- High Winds, Heavy Seas -- INTO THE WINDS.  
Light Winds, Heavy Swells -- PARALLEL TO SWELLS.

### NOTE

If no power is available, approach at 70 KIAS with flaps up or at 65 KIAS with 10° flaps.

- (6) Cabin Doors -- UNLATCH.
- (7) Touchdown -- LEVEL ATTITUDE AT ESTABLISHED DESCENT.
- (8) Face -- CUSHION at touchdown with folded coat or seat cushion.
- (9) Airplane -- EVACUATE through cabin doors. If necessary, open vent window to flood cabin to equalize pressure so doors can be opened.
- (10) Life Vests and Raft -- INFLATE.

### FIRES

#### DURING START ON GROUND

- (1) Cranking -- CONTINUE, to get a start which would suck the flames and accumulated fuel through the carburetor and into the engine.

If engine starts:

- (2) Power -- 1700 RPM for a few minutes.
- (3) Engine -- SHUTDOWN and inspect for damage.

If engine fails to start:

- (4) Throttle -- FULL OPEN.
- (5) Mixture -- IDLE CUT-OFF.

- (6) Cranking -- CONTINUE for two or three minutes.
- (7) Fire Extinguisher -- OBTAIN (have ground attendants obtain if not installed).
- (8) Engine -- SECURE.
  - a. Master Switch -- OFF.
  - b. Ignition Switch -- OFF.
  - c. Fuel Selector Valve -- OFF.
- (9) Fire -- EXTINGUISH using fire extinguisher, seat cushion, wool blanket, or dirt. If practical try to remove carburetor air filter if it is ablaze.
- (10) Fire Damage -- INSPECT, repair damage or replace damaged components or wiring before conducting another flight.

#### ENGINE FIRE IN FLIGHT

- (1) Mixture -- IDLE CUT-OFF.
- (2) Fuel Selector Valve -- OFF.
- (3) Master Switch -- OFF.
- (4) Cabin Heat and Air -- OFF (except overhead vents).
- (5) Airspeed -- 100 KIAS (If fire is not extinguished, increase glide speed to find an airspeed which will provide an incombustible mixture).
- (6) Forced Landing -- EXECUTE (as described in Emergency Landing Without Engine Power).

#### ELECTRICAL FIRE IN FLIGHT

- (1) Master Switch -- OFF.
- (2) All Other Switches (except ignition switch) -- OFF.
- (3) Vents/Cabin Air/Heat -- CLOSED.
- (4) Fire Extinguisher -- ACTIVATE (if available).

If fire appears out and electrical power is necessary for continuance of flight:

- (5) Master Switch -- ON.
- (6) Circuit Breakers -- CHECK for faulty circuit, do not reset.
- (7) Radio/Electrical Switches -- ON one at a time, with delay after each until short circuit is localized.
- (8) Vents/Cabin Air/Heat -- OPEN when it is ascertained that fire is completely extinguished.

#### CABIN FIRE

- (1) Master Switch -- OFF.
- (2) Vents/Cabin Air/Heat -- CLOSED (to avoid drafts).
- (3) Fire Extinguisher -- ACTIVATE (if available).



## **WARNING**

After discharging an extinguisher within a closed cabin, ventilate the cabin.

- (4) Land the airplane as soon as possible to inspect for damage.

### **WING FIRE**

- (1) Navigation Light Switch -- OFF.
- (2) Strobe Light Switch (if installed).-- OFF.
- (3) Pitot Heat Switch (if installed) -- OFF.

### **NOTE**

Perform a sideslip to keep the flames away from the fuel tank and cabin, and land as soon as possible using flaps only as required for final approach and touchdown.

### **ICING**

#### **INADVERTENT ICING ENCOUNTER**

- (1) Turn pitot heat switch ON (if installed).
- (2) Turn back or change altitude to obtain an outside air temperature that is less conducive to icing.
- (3) Pull cabin heat control full out and rotate defroster control clockwise to obtain maximum defroster airflow.
- (4) Increase engine speed to minimize ice build-up on propeller blades.
- (5) Watch for signs of carburetor air filter ice and apply carburetor heat as required. An unexplained loss in manifold pressure could be caused by carburetor ice or air intake filter ice. Lean the mixture if carburetor heat is used continuously.
- (6) Plan a landing at the nearest airport. With an extremely rapid ice build-up, select a suitable "off airport" landing site.
- (7) With an ice accumulation of 1/4 inch or more on the wing leading edges, be prepared for significantly higher stall speed.
- (8) Leave wing flaps retracted. With a severe ice build-up on the horizontal tail, the change in wing wake airflow direction caused by wing flap extension could result in a loss of elevator effectiveness.
- (9) Perform a landing approach using a forward slip, if necessary, for improved visibility.
- (10) Approach at 80 to 90 KIAS, depending upon the amount of ice accumulation.

- (11) Perform a landing in level attitude.

**STATIC SOURCE BLOCKAGE**  
(Erroneous Instrument Reading Suspected)

- (1) Alternate Static Source Valve -- PULL ON.
- (2) Airspeed -- Consult appropriate table in Section 5 or climb and approach 3 knots faster than normal.
- (3) Altitude -- Cruise 50 feet higher and approach 30 feet higher than normal.

**LANDING WITH A FLAT TIRE**

- (1) Approach -- NORMAL.
- (2) Wing Flaps -- FULL DOWN.
- (3) Touchdown -- GOOD TIRE FIRST, hold airplane off flat tire as long as possible.

**ELECTRICAL POWER SUPPLY SYSTEM  
MALFUNCTIONS**

**OVER-VOLTAGE LIGHT ILLUMINATES**

- (1) Master Switch -- OFF (both sides).
- (2) Master Switch -- ON.
- (3) Over-Voltage Light -- OFF.

If over-voltage light illuminates again:

- (4) Flight -- TERMINATE as soon as practical.

**AMMETER SHOWS DISCHARGE**

- (1) Alternator -- OFF.
- (2) Nonessential Electrical Equipment -- OFF.
- (3) Flight -- TERMINATE as soon as practical.

## AMPLIFIED PROCEDURES

### ENGINE FAILURE

If an engine failure occurs during the takeoff run, the most important thing to do is stop the airplane on the remaining runway. Those extra items on the checklist will provide added safety during a failure of this type.

Prompt lowering of the nose to maintain airspeed and establish a glide attitude is the first response to an engine failure after takeoff. In most cases, the landing should be planned straight ahead with only small changes in direction to avoid obstructions. Altitude and airspeed are seldom sufficient to execute a 180° gliding turn necessary to return to the runway. The checklist procedures assume that adequate time exists to secure the fuel and ignition systems prior to touchdown.

After an engine failure in flight, the best glide speed as shown in Figure 3-1 should be established as quickly as possible. While gliding toward a suitable landing area, an effort should be made to identify the cause of the failure. If time permits, an engine restart should be attempted as shown in the checklist. If the engine cannot be restarted, a forced landing without power must be completed.

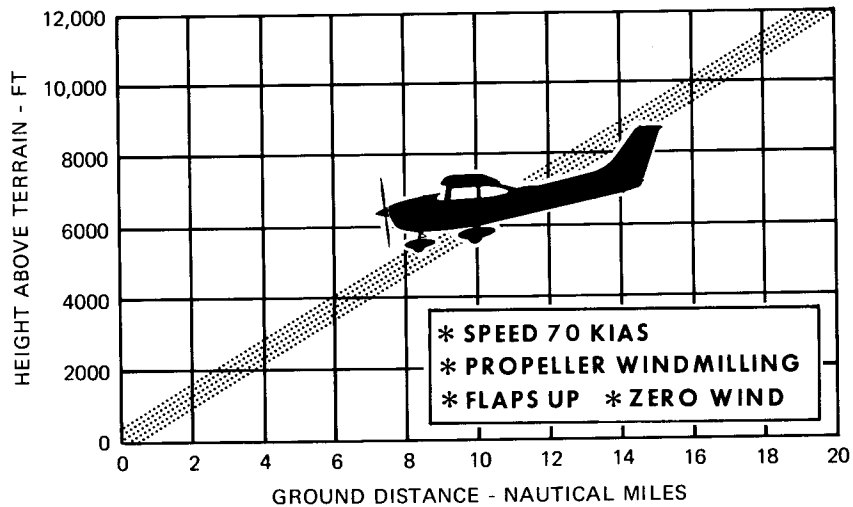

Figure 3-1. Maximum Glide

## FORCED LANDINGS

If all attempts to restart the engine fail and a forced landing is imminent, select a suitable field and prepare for the landing as discussed in the checklist for Emergency Landing Without Engine Power.

Before attempting an "off airport" landing with engine power available, one should drag the landing area at a safe but low altitude to inspect the terrain for obstructions and surface conditions, proceeding as discussed under the Precautionary Landing With Engine Power checklist.

Prepare for ditching by securing or jettisoning heavy objects located in the baggage area and collect folded coats or cushions for protection of occupants' face at touchdown. Transmit Mayday message on 121.5 MHz giving location and intentions.

## LANDING WITHOUT ELEVATOR CONTROL

Trim for horizontal flight with an airspeed of approximately 80 KIAS by using throttle and elevator trim control. Then do not change the elevator trim control setting; control the glide angle by adjusting power exclusively.

At flareout the nose-down moment resulting from power reduction is an adverse factor and the airplane may hit on the nose wheel. Consequently, at flareout, the elevator trim control should be adjusted toward the full nose-up position and the power adjusted so that the airplane will rotate to the horizontal attitude for touchdown. Close the throttle at touchdown.

## FIRES

Although engine fires are extremely rare in flight, the steps of the appropriate checklist should be followed if one is encountered. After completion of this procedure, execute a forced landing.

The initial indication of an electrical fire is usually the odor of burning insulation. The checklist for this problem should result in elimination of the fire.

## EMERGENCY OPERATION IN CLOUDS (Vacuum System Failure)

In the event of a vacuum system failure during flight in marginal

weather, the directional indicator and attitude indicator will be disabled, and the pilot will have to rely on the turn coordinator or the turn and bank indicator if he inadvertently flies into clouds. The following instructions assume that only the electrically-powered turn coordinator or the turn and bank indicator is operative, and that the pilot is not completely proficient in instrument flying.

#### EXECUTING A 180° TURN IN CLOUDS

Upon inadvertently entering the clouds, an immediate plan should be made to turn back as follows:

- (1) Note the time of the minute hand and observe the position of the sweep second hand on the clock.
- (2) When the sweep second hand indicates the nearest half-minute, initiate a standard rate left turn, holding the turn coordinator symbolic airplane wing opposite the lower left index mark for 60 seconds. Then roll back to level flight by leveling the miniature airplane.
- (3) Check accuracy of the turn by observing the compass heading which should be the reciprocal of the original heading.
- (4) If necessary, adjust heading primarily with skidding motions rather than rolling motions so that the compass will read more accurately.
- (5) Maintain altitude and airspeed by cautious application of elevator control. Avoid overcontrolling by keeping the hands off the control wheel and steering only with rudder.

#### EMERGENCY DESCENT THROUGH CLOUDS

If conditions preclude reestablishment of VFR flight by a 180° turn, a descent through a cloud deck to VFR conditions may be appropriate. If possible, obtain radio clearance for an emergency descent through clouds. To guard against a spiral dive, choose an easterly or westerly heading to minimize compass card swings due to changing bank angles. In addition, keep hands off the control wheel and steer a straight course with rudder control by monitoring the turn coordinator. Occasionally check the compass heading and make minor corrections to hold an approximate course. Before descending into the clouds, set up a stabilized let-down condition as follows:

- (1) Apply full rich mixture.
- (2) Apply full carburetor heat.
- (3) Reduce power to set up a 500 to 800 ft./min. rate of descent.
- (4) Adjust the elevator and rudder trim control wheels for a stabilized descent at 80 KIAS.
- (5) Keep hands off control wheel.

- (6) Monitor turn coordinator and make corrections by rudder alone.
- (7) Adjust rudder trim to relieve unbalanced rudder force, if present.
- (8) Check trend of compass card movement and make cautious corrections with rudder to stop turn.
- (9) Upon breaking out of clouds, resume normal cruising flight.

#### RECOVERY FROM A SPIRAL DIVE

If a spiral is encountered, proceed as follows:

- (1) Close the throttle.
- (2) Stop the turn by using coordinated aileron and rudder control to align the symbolic airplane in the turn coordinator with the horizon reference line.
- (3) Cautiously apply elevator back pressure to slowly reduce the indicated airspeed to 80 KIAS.
- (4) Adjust the elevator trim control to maintain an 80 KIAS glide.
- (5) Keep hands off the control wheel, using rudder control to hold a straight heading. Use rudder trim to relieve unbalanced rudder force, if present.
- (6) Apply carburetor heat.
- (7) Clear engine occasionally, but avoid using enough power to disturb the trimmed glide.
- (8) Upon breaking out of clouds, resume normal cruising flight.

#### FLIGHT IN ICING CONDITIONS

Flight into icing conditions is prohibited. An inadvertent encounter with these conditions can best be handled using the checklist procedures. The best procedure, of course, is to turn back or change altitude to escape icing conditions.

#### STATIC SOURCE BLOCKED

If erroneous readings of the static source instruments (airspeed, altimeter and rate-of-climb) are suspected, the alternate static source valve should be pulled on, thereby supplying static pressure to these instruments from the cabin. Cabin pressures will vary with open ventilators or windows and with airspeed.

#### NOTE

In an emergency on airplanes not equipped with an alternate static source, cabin pressure can be supplied to the static pressure instruments by breaking the glass in the face of the rate-of-climb indicator.

With windows closed, maximum airspeed and altimeter variation from normal occurs with the vents closed and reaches 4 knots and 50 feet respectively at maximum cruise (instruments read high). During approach, typical variations are 3 knots and 25 feet respectively (reads high). Opening the vents tend to reduce these variations to zero.

With windows open, variations up to 10 knots and 50 feet occur near stall (reads low) and up to 10 knots and 100 feet at maximum cruise (reads high). During approach, typical variations are 3 knots and 20 feet (reads low).

With the alternate static source on, fly the airplane at airspeeds and altitudes which compensate for the noted variations from normal indications. For more exact airspeed correction, refer to the alternate static source airspeed calibration table in Section 5, appropriate to the vent/window(s) configuration.

## SPINS

Intentional spins are prohibited in this airplane. Should an inadvertent spin occur, the following recovery procedure should be used:

- (1) RETARD THROTTLE TO IDLE POSITION.
- (2) PLACE AILERONS IN NEUTRAL POSITION.
- (3) APPLY AND HOLD FULL RUDDER OPPOSITE TO THE DIRECTION OF ROTATION.
- (4) JUST AFTER THE RUDDER REACHES THE STOP, MOVE THE WHEEL BRISKLY FORWARD FAR ENOUGH TO BREAK THE STALL.
- (5) HOLD THESE CONTROL INPUTS UNTIL ROTATION STOPS. Premature relaxation of the control inputs may extend the recovery.
- (6) AS ROTATION STOPS, NEUTRALIZE RUDDER, AND MAKE A SMOOTH RECOVERY FROM THE RESULTING DIVE.

### NOTE

If disorientation precludes a visual determination of the direction of rotation, the symbolic airplane in the turn coordinator or the needle of the turn and bank indicator may be referred to for this information.

## ROUGH ENGINE OPERATION OR LOSS OF POWER

### CARBURETOR ICING

An unexplained drop in manifold pressure and eventual engine rough-

ness may result from the formation of carburetor ice. To clear the ice, apply full throttle and pull the carburetor heat knob full out until the engine runs smoothly; then remove carburetor heat and readjust the throttle. If conditions require the continued use of carburetor heat in cruise flight, use the minimum amount of heat necessary to prevent ice from forming and lean the mixture for smoothest engine operation.

### **SPARK PLUG FOULING**

A slight engine roughness in flight may be caused by one or more spark plugs becoming fouled by carbon or lead deposits. This may be verified by turning the ignition switch momentarily from BOTH to either L or R position. An obvious power loss in single ignition operation is evidence of spark plug or magneto trouble. Assuming that spark plugs are the more likely cause, lean the mixture to the recommended lean setting for cruising flight. If the problem does not clear up in several minutes, determine if a richer mixture setting will produce smoother operation. If not, proceed to the nearest airport for repairs using the BOTH position of the ignition switch unless extreme roughness dictates the use of single ignition position.

### **MAGNETO MALFUNCTION**

A sudden engine roughness or misfiring is usually evidence of magneto problems. Switching from BOTH to either L or R ignition switch position will identify which magneto is malfunctioning. Select different power settings and enrichen the mixture to determine if continued operation on BOTH magnetos is practicable. If not, switch to the good magneto and proceed to the nearest airport for repairs.

### **LOW OIL PRESSURE**

If low oil pressure is accompanied by normal oil temperature, there is a possibility the oil pressure gage or relief valve is malfunctioning. A leak in the line to the gage is not necessarily cause for an immediate precautionary landing because an orifice in this line will prevent a sudden loss of oil from the engine sump. However, a landing at the nearest airport would be advisable to inspect the source of trouble.

If a total loss of oil pressure is accompanied by a rise in oil temperature, there is good reason to suspect an engine failure is imminent. Reduce engine power immediately and select a suitable forced landing field. Use only the minimum power required to reach the desired touchdown spot.



## **ELECTRICAL POWER SUPPLY SYSTEM MALFUNCTIONS**

Malfunctions in the electrical power supply system can be detected by periodic monitoring of the ammeter and over-voltage warning light; however, the cause of these malfunctions is usually difficult to determine. A broken alternator drive belt or wiring is most likely the cause of alternator failures, although other factors could cause the problem. A damaged or improperly adjusted voltage regulator can also cause malfunctions. Problems of this nature constitute an electrical emergency and should be dealt with immediately. Electrical power malfunctions usually fall into two categories: excessive rate of charge and insufficient rate of charge. The following paragraphs describe the recommended remedy for each situation.

### **EXCESSIVE RATE OF CHARGE**

After engine starting and heavy electrical usage at low engine speeds (such as extended taxiing) the battery condition will be low enough to accept above normal charging during the initial part of a flight. However, after thirty minutes of cruising flight, the ammeter should be indicating less than two needle widths of charging current. If the charging rate were to remain above this value on a long flight, the battery would overheat and evaporate the electrolyte at an excessive rate. Electronic components in the electrical system could be adversely affected by higher than normal voltage if a faulty voltage regulator setting is causing the overcharging. To preclude these possibilities, an over-voltage sensor will automatically shut down the alternator and the over-voltage warning light will illuminate if the charge voltage reaches approximately 16 volts. Assuming that the malfunction was only momentary, an attempt should be made to reactivate the alternator system. To do this, turn both sides of the master switch off and then on again. If the problem no longer exists, normal alternator charging will resume and the warning light will go off. If the light illuminates again, a malfunction is confirmed. In this event, the flight should be terminated and/or the current drain on the battery minimized because the battery can supply the electrical system for only a limited period of time. If the emergency occurs at night, power must be conserved for later operation of the wing flaps and possible use of the landing lights during landing.

### **INSUFFICIENT RATE OF CHARGE**

If the ammeter indicates a continuous discharge rate in flight, the alternator is not supplying power to the system and should be shut down since the alternator field circuit may be placing an unnecessary load on the system. All nonessential equipment should be turned off and the flight terminated as soon as practical.



# SECTION 4

## NORMAL PROCEDURES

### TABLE OF CONTENTS

	Page
Introduction . . . . .	4-3
Speeds For Normal Operation . . . . .	4-3

#### CHECKLIST PROCEDURES

Preflight Inspection. . . . .	4-5
Cabin . . . . .	4-5
Empennage . . . . .	4-5
Right Wing, Trailing Edge . . . . .	4-5
Right Wing . . . . .	4-5
Nose . . . . .	4-5
Left Wing . . . . .	4-6
Left Wing, Leading Edge . . . . .	4-6
Left Wing, Trailing Edge . . . . .	4-6
Before Starting Engine . . . . .	4-6
Starting Engine . . . . .	4-7
Before Takeoff . . . . .	4-7
Takeoff . . . . .	4-8
Normal Takeoff . . . . .	4-8
Maximum Performance Takeoff . . . . .	4-8
Enroute Climb . . . . .	4-8
Normal Climb . . . . .	4-8
Maximum Performance Climb . . . . .	4-8
Cruise . . . . .	4-9
Descent . . . . .	4-9
Before Landing . . . . .	4-9
Balked Landing . . . . .	4-9
Normal Landing . . . . .	4-9
After Landing . . . . .	4-10
Securing Airplane . . . . .	4-10

#### AMPLIFIED PROCEDURES

Starting Engine. . . . .	4-11
	4-1

**TABLE OF CONTENTS (Continued)**

	Page
Taxiing . . . . .	4-11
Before Takeoff . . . . .	4-13
Warm-Up . . . . .	4-13
Magnetto Check . . . . .	4-13
Alternator Check . . . . .	4-13
Takeoff . . . . .	4-13
Power Check . . . . .	4-13
Wing Flap Settings . . . . .	4-14
Crosswind Takeoff . . . . .	4-14
Enroute Climb . . . . .	4-15
Cruise . . . . .	4-15
Leaning With A Cessna Economy Mixture Indicator (EGT) . . . . .	4-17
Stalls . . . . .	4-17
Landing . . . . .	4-18
Normal Landing . . . . .	4-18
Short Field Landing . . . . .	4-18
Crosswind Landing . . . . .	4-18
Balked Landing . . . . .	4-18
Cold Weather Operation . . . . .	4-18
Starting . . . . .	4-18
Operation . . . . .	4-20
Hot Weather Operation . . . . .	4-21
Noise Abatement . . . . .	4-21

## INTRODUCTION

Section 4 provides checklist and amplified procedures for the conduct of normal operation. Normal procedures associated with Optional Systems can be found in Section 9.

## SPEEDS FOR NORMAL OPERATION

Unless otherwise noted, the following speeds are based on a maximum weight of 2950 pounds and may be used for any lesser weight. However, to achieve the performance specified in Section 5 for takeoff distance, the speed appropriate to the particular weight must be used.

### Takeoff:

Normal Climb Out . . . . .	70-80 KIAS
Maximum Performance Takeoff, Speed at 50 Feet . . . . .	57 KIAS

### Enroute Climb, Flaps Up:

Normal, Sea Level . . . . .	95 KIAS
Normal, 10,000 Feet . . . . .	85 KIAS
Best Rate of Climb, Sea Level . . . . .	80 KIAS
Best Rate of Climb, 10,000 Feet . . . . .	73 KIAS
Best Angle of Climb, Sea Level . . . . .	59 KIAS
Best Angle of Climb, 10,000 Feet . . . . .	63 KIAS

### Landing Approach:

Normal Approach, Flaps Up . . . . .	70-80 KIAS
Normal Approach, Flaps 40° . . . . .	60-70 KIAS
Short Field Approach, Flaps 40° . . . . .	60 KIAS

### Balked Landing:

During Transition to Maximum Power, Flaps 20° . . . . .	70 KIAS
---	---------

### Maximum Recommended Turbulent Air Penetration Speed:

2950 Lbs . . . . .	110 KIAS
2450 Lbs . . . . .	100 KIAS
1950 Lbs . . . . .	89 KIAS

### Maximum Demonstrated Crosswind Velocity:

Takeoff . . . . .	20 KNOTS
Landing . . . . .	15 KNOTS

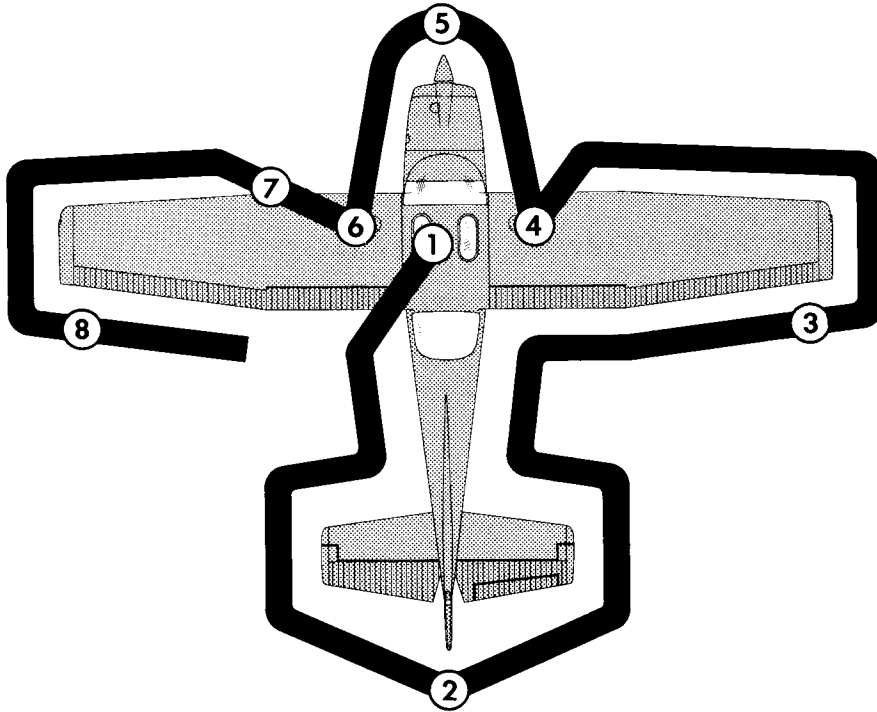

NOTE

Visually check airplane for general condition during walk-around inspection. In cold weather, remove even small accumulations of frost, ice or snow from wing, tail and controls surfaces. Also, make sure that the control surfaces contain no internal accumulations of ice or debris. If a night flight is planned, check operation of all lights, and make sure a flashlight is available.

Figure 4-1. Preflight Inspection

## CHECKLIST PROCEDURES

### PREFLIGHT INSPECTION

#### ① CABIN

- (1) Control Wheel Lock -- REMOVE.
- (2) Ignition Switch -- OFF.
- (3) Master Switch -- ON.
- (4) Fuel Quantity Indicators -- CHECK QUANTITY.
- (5) Master Switch -- OFF.
- (6) Fuel Selector Valve -- BOTH.
- (7) Baggage Door -- CHECK for security, lock with key if child's seat is to be occupied.

#### ② EMPENNAGE

- (1) Rudder Gust Lock -- REMOVE.
- (2) Tail Tie-Down -- DISCONNECT.
- (3) Control Surfaces -- CHECK freedom of movement and security.

#### ③ RIGHT WING Trailing Edge

- (1) Aileron -- CHECK freedom of movement and security.

#### ④ RIGHT WING

- (1) Wing Tie-Down -- DISCONNECT.
- (2) Main Wheel Tire -- CHECK for proper inflation.
- (3) Before first flight of the day and after each refueling, use sampler cup and drain small quantity of fuel from fuel tank sump quick-drain valve to check for water, sediment and proper fuel grade (red).
- (4) Fuel Quantity -- CHECK VISUALLY for desired level.
- (5) Fuel Filler Cap -- SECURE and vent unobstructed.

#### ⑤ NOSE

- (1) Static Source Openings (both sides of fuselage) -- CHECK for stoppage.
- (2) Propeller and Spinner -- CHECK for nicks, security and oil leaks.
- (3) Landing Lights -- CHECK for condition and cleanliness.
- (4) Carburetor Air Filter -- CHECK for restrictions by dust or other foreign matter.

- (5) Nose Wheel Strut and Tire -- CHECK for proper inflation.
- (6) Nose Tie-Down -- DISCONNECT.
- (7) Engine Oil Level -- CHECK. Do not operate with less than nine quarts. Fill to twelve quarts for extended flight.
- (8) Before first flight of the day and after each refueling, pull out strainer drain knob for about four seconds to clear fuel strainer of possible water and sediment. Check strainer drain closed. If water is observed, the fuel system may contain additional water, and further draining of the system at the strainer, fuel tank sumps, and fuel selector valve drain plug will be necessary.

**⑥ LEFT WING**

- (1) Main Wheel Tire -- CHECK for proper inflation.
- (2) Before first flight of the day and after each refueling, use sampler cup and drain small quantity of fuel from fuel tank sump quick-drain valve to check for water, sediment, and proper fuel grade (red).
- (3) Fuel Quantity -- CHECK VISUALLY for desired level.
- (4) Fuel Filler Cap -- SECURE and vent unobstructed.

**⑦ LEFT WING Leading Edge**

- (1) Pitot Tube Cover -- REMOVE and check opening for stoppage.
- (2) Fuel Tank Vent Opening -- CHECK for stoppage.
- (3) Stall Warning Vane -- CHECK for freedom of movement while master switch is momentarily turned ON (horn should sound when vane is pushed upward).
- (4) Wing Tie-Down -- DISCONNECT.

**⑧ LEFT WING Trailing Edge**

- (1) Aileron -- CHECK for freedom of movement and security.

**BEFORE STARTING ENGINE**

- (1) Preflight Inspection -- COMPLETE.
- (2) Seats, Belts, Shoulder Harnesses -- ADJUST and LOCK.
- (3) Fuel Selector Valve -- BOTH.
- (4) Radios, Autopilot, Electrical Equipment -- OFF.
- (5) Brakes -- TEST and SET.
- (6) Cowl Flaps -- OPEN (move lever out of locking hole to reposition).
- (7) Circuit Breakers -- CHECK IN.



## STARTING ENGINE

- (1) Mixture -- RICH.
- (2) Propeller -- HIGH RPM.
- (3) Carburetor Heat -- COLD.
- (4) Throttle -- OPEN 1/2 INCH.
- (5) Prime -- AS REQUIRED.
- (6) Master Switch -- ON.
- (7) Propeller Area -- CLEAR.
- (8) Ignition Switch -- START (release when engine starts).

### NOTE

If engine has been overprimed, start with throttle 1/4 to 1/2 open. Reduce throttle to idle when engine fires.

- (9) Oil Pressure -- CHECK.

### NOTE

After starting, check for oil pressure indication within 30 seconds in normal temperatures and 60 seconds in cold temperatures. If no indication appears, shut off engine and investigate.

## BEFORE TAKEOFF

- (1) Cabin Doors and Windows -- CLOSED and LOCKED.
- (2) Flight Controls -- FREE and CORRECT.
- (3) Elevator and Rudder Trim -- TAKEOFF.
- (4) Flight Instruments -- SET.
- (5) Radios -- SET.
- (6) Autopilot (if installed) -- OFF.
- (7) Fuel Selector Valve -- BOTH.
- (8) Parking Brake -- SET.
- (9) Throttle -- 1700 RPM.
  - a. Magnetos -- CHECK (RPM drop should not exceed 150 RPM on either magneto or 50 RPM differential between magnetos).
  - b. Propeller -- CYCLE from high to low RPM; return to high RPM (full in).
  - c. Carburetor Heat -- CHECK for RPM drop.
  - d. Engine Instruments and Ammeter -- CHECK.
  - e. Suction Gage -- CHECK.
- (10) Flashing Beacon, Navigation Lights and/or Strobe Lights -- ON as required.

- (11) Throttle Friction Lock -- ADJUST.
- (12) Wing Flaps -- 0° - 20°.

## **TAKEOFF**

### **NORMAL TAKEOFF**

- (1) Wing Flaps -- 0° - 20°.
- (2) Carburetor Heat -- COLD.
- (3) Power -- FULL THROTTLE and 2600 RPM.
- (4) Elevator Control -- LIFT NOSE WHEEL at 50 KIAS.
- (5) Climb Speed -- 70 KIAS (flaps 20°).  
80 KIAS (flaps UP).

### **MAXIMUM PERFORMANCE TAKEOFF**

- (1) Wing Flaps -- 20°.
- (2) Carburetor Heat -- COLD.
- (3) Brakes -- APPLY.
- (4) Power -- FULL THROTTLE and 2600 RPM.
- (5) Brakes -- RELEASE.
- (6) Elevator Control -- MAINTAIN SLIGHTLY TAIL LOW ATTITUDE.
- (7) Climb Speed -- 57 KIAS (until all obstacles are cleared).
- (8) Wing Flaps -- RETRACT slowly after reaching 70 KIAS.

## **ENROUTE CLIMB**

### **NORMAL CLIMB**

- (1) Airspeed -- 90 KIAS.
- (2) Power -- 23 INCHES Hg and 2450 RPM.
- (3) Fuel Selector Valve -- BOTH.
- (4) Mixture -- LEAN (as required for power, temperature and smoothness).
- (5) Cowl Flaps -- OPEN as required.

### **MAXIMUM PERFORMANCE CLIMB**

- (1) Airspeed -- 80 KIAS at sea level to 73 KIAS at 10,000 feet.
- (2) Power -- FULL THROTTLE and 2600 RPM.
- (3) Mixture -- FULL RICH unless engine is rough.
- (4) Cowl Flaps -- FULL OPEN.

## CRUISE

- (1) Power -- 15-23 INCHES Hg, 2200-2450 RPM (no more than 75% power).
- (2) Elevator and Rudder Trim -- ADJUST.
- (3) Mixture -- LEAN.
- (4) Cowl Flaps -- CLOSED.

## DESCENT

- (1) Power -- AS DESIRED.
- (2) Carburetor Heat -- AS REQUIRED to prevent carburetor icing.
- (3) Mixture -- ENRICHEN as required.
- (4) Cowl Flaps -- CLOSED.
- (5) Wing Flaps -- AS DESIRED (0° - 10° below 140 KIAS, 10° - 40° below 95 KIAS).

## BEFORE LANDING

- (1) Seats, Belts, Shoulder Harnesses -- ADJUST and LOCK.
- (2) Fuel Selector Valve -- BOTH.
- (3) Propeller -- HIGH RPM.
- (4) Cowl Flaps -- CLOSED.
- (5) Carburetor Heat -- ON (apply full heat before closing throttle).
- (6) Airspeed -- 70-80 KIAS (flaps UP).
- (7) Wing Flaps -- 0° - 40° (below 95 KIAS).
- (8) Airspeed -- 60 - 70 KIAS (flaps DOWN).
- (9) Elevator and Rudder Trim -- ADJUST.

## BALKED LANDING

- (1) Power -- FULL THROTTLE and 2600 RPM.
- (2) Carburetor Heat -- COLD.
- (3) Wing Flaps -- RETRACT to 20°.
- (4) Airspeed -- 70 KIAS.
- (5) Wing Flaps -- RETRACT slowly.
- (6) Cowl Flaps -- OPEN.

## NORMAL LANDING

- (1) Touchdown -- MAIN WHEELS FIRST.
- (2) Landing Roll -- LOWER NOSE WHEEL GENTLY.

- (3) Braking -- MINIMUM REQUIRED.

### **AFTER LANDING**

- (1) Wing Flaps -- UP.
- (2) Carburetor Heat -- COLD.
- (3) Cowl Flaps -- OPEN.

### **SECURING AIRPLANE**

- (1) Parking Brake -- SET.
- (2) Radios, Electrical Equipment, Autopilot -- OFF.
- (3) Throttle -- IDLE.
- (4) Mixture -- IDLE CUT-OFF (pulled full out).
- (5) Ignition Switch -- OFF.
- (6) Master Switch -- OFF.
- (7) Control Lock -- INSTALL.
- (8) Fuel Selector Valve -- RIGHT.

## AMPLIFIED PROCEDURES

### STARTING ENGINE

Ordinarily the engine starts easily with one or two strokes of the primer in warm temperatures to six strokes in cold weather with the throttle open approximately 1/2 inch. In extremely cold temperatures it may be necessary to continue priming while cranking. Weak intermittent firing followed by puffs of black smoke from the exhaust stack indicate overpriming or flooding. Excess fuel can be cleared from the combustion chambers by the following procedure: Set the mixture control full lean and the throttle full open; then crank the engine through several revolutions with the starter. Repeat the starting procedure without any additional priming.

If the engine is underprimed (most likely in cold weather with a cold engine) it will not fire at all. Additional priming will be necessary for the next starting attempt. As soon as the cylinders begin to fire, open the throttle slightly to keep it running.

If prolonged cranking is necessary, allow the starter motor to cool at frequent intervals, since excessive heat may damage the armature.

After starting, if the oil gage does not begin to show pressure within 30 seconds in the summertime and about twice that long in very cold weather, stop engine and investigate. Lack of oil pressure can cause serious engine damage. After starting, avoid the use of carburetor heat unless icing conditions prevail.

#### NOTE

Additional details concerning cold weather starting and operation may be found under COLD WEATHER OPERATION paragraphs in this section.

### TAXIING

When taxiing, it is important that speed and use of brakes be held to a minimum and that all controls be utilized (see Taxiing Diagram, figure 4-2) to maintain directional control and balance.

The carburetor heat control knob should be pushed full in during all ground operations unless heat is absolutely necessary for smooth engine

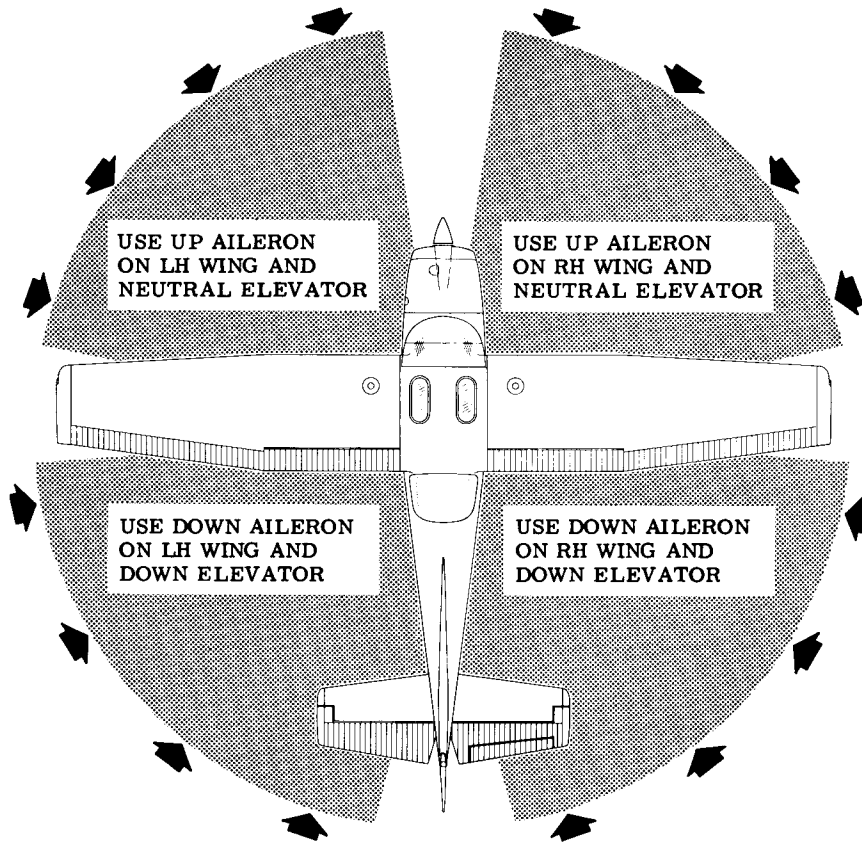

CODE

WIND DIRECTION 

NOTE

Strong quartering tail winds require caution. Avoid sudden bursts of the throttle and sharp braking when the airplane is in this attitude. Use the steerable nose wheel and rudder to maintain direction.

Figure 4-2. Taxiing Diagram

operation. When the knob is pulled out to the heat position, air entering the engine is not filtered.

Taxiing over loose gravel or cinders should be done at low engine speed to avoid abrasion and stone damage to the propeller tips.

## **BEFORE TAKEOFF**

### **WARM-UP**

Since the engine is closely cowled for efficient in-flight cooling, precautions should be taken to avoid overheating on the ground. Full throttle checks on the ground are not recommended unless the pilot has good reason to suspect that the engine is not turning up properly.

### **MAGNETO CHECK**

The magneto check should be made at 1700 RPM as follows. Move ignition switch first to R position, and note RPM. Next move switch back to BOTH to clear the other set of plugs. Then move switch to L position, note RPM and return the switch to the BOTH position. RPM drop should not exceed 150 RPM on either magneto or show greater than 50 RPM differential between magnetos. If there is a doubt concerning operation of the ignition system, RPM checks at higher engine speed will usually confirm whether a deficiency exists.

An absence of RPM drop may be an indication of faulty grounding of one side of the ignition system or should be cause for suspicion that the magneto timing is set in advance of the setting specified.

### **ALTERNATOR CHECK**

Prior to flight where verification of proper alternator and voltage regulator operation is essential (such as night or instrument flights), a positive verification can be made by loading the electrical system momentarily (3 to 5 seconds) with the landing light during the engine runup (1700 RPM). The ammeter will remain within a needle width of the initial reading if the alternator and voltage regulator are operating properly.

## **TAKEOFF**

### **POWER CHECK**

It is important to check full-throttle engine operation early in the

takeoff run. Any sign of rough engine operation or sluggish engine acceleration is good cause for discontinuing the takeoff.

Full-throttle runups over loose gravel are especially harmful to propeller tips. When takeoffs must be made over a gravel surface, it is very important that the throttle be advanced slowly. This allows the airplane to start rolling before high RPM is developed, and the gravel will be blown back of the propeller rather than pulled into it. When unavoidable small dents appear in the propeller blades they should be corrected immediately as described in Section 8 under Propeller Care.

After full throttle is applied, adjust the throttle friction lock clockwise to prevent the throttle from creeping back from a maximum power position. Similar friction lock adjustment should be made as required in other flight conditions to maintain a fixed throttle setting.

### WING FLAP SETTINGS

Normal takeoffs are accomplished with wing flaps 0° to 20°. Using 20° wing flaps reduces the ground run and total distance over an obstacle by approximately 20 per cent. Flap deflections greater than 20° are not approved for takeoff.

If 20° wing flaps are used for takeoff, they should be left down until all obstacles are cleared and a safe flap retraction speed of 70 KIAS is reached. To clear an obstacle with wing flaps 20°, an obstacle clearance speed of 57 KIAS should be used.

Soft field takeoffs are performed with 20° flaps by lifting the airplane off the ground as soon as practical in a slightly tail-low attitude. If no obstacles are ahead, the airplane should be leveled off immediately to accelerate to a safer climb speed.

With wing flaps retracted and no obstructions ahead, a climb-out speed of 80 KIAS would be most efficient.

### CROSSWIND TAKEOFF

Takeoffs into strong crosswinds normally are performed with the minimum flap setting necessary for the field length, to minimize the drift angle immediately after takeoff. The airplane is accelerated to a speed slightly higher than normal, then pulled off abruptly to prevent possible settling back to the runway while drifting. When clear of the ground, make a coordinated turn into the wind to correct for drift.



## ENROUTE CLIMB

A cruising climb at 23 inches of manifold pressure, 2450 RPM (approximately 75% power) and 85 - 95 KIAS is normally recommended to provide an optimum combination of performance, visibility ahead, engine cooling, economy, and passenger comfort (due to lower noise level). A cruise recommended lean mixture may normally be used during this type of climb.

If it is necessary to climb rapidly to clear mountains or reach favorable winds at high altitudes, the best rate-of-climb speed should be used with maximum power. This speed is 80 KIAS at sea level, decreasing to 73 KIAS at 10,000 feet. The mixture should be full rich unless the engine is rough or loses noticeable power due to excessive richness.

If an obstruction ahead requires a steep climb angle, a best angle-of-climb speed should be used with flaps up and maximum power. This speed is 59 KIAS at sea level, increasing to 63 KIAS at 10,000 feet.

## CRUISE

Normal cruising is performed between 55% and 75% power. The corresponding power settings and fuel consumption for various altitudes can be determined by using your Cessna Power Computer or the Data in Section 5.

### NOTE

Cruising should be done at 75% power as much as practical until a total of 50 hours has accumulated or oil consumption has stabilized. This is to ensure proper seating of the rings and is applicable to new engines, and engines in service following cylinder replacement or top overhaul of one or more cylinders.

The Cruise Performance Table, figure 4-3, illustrates the true airspeed and nautical miles per gallon during cruise for various altitudes and percent powers. This table should be used as a guide, along with the available winds aloft information, to determine the most favorable altitude and power setting for a given trip. The selection of cruise altitude on the basis of the most favorable wind conditions and the use of low power settings are significant factors that should be considered on every trip to reduce fuel consumption.

For reduced noise levels, it is desirable to select the lowest RPM in the green arc range for a given percent power that will provide smooth engine operation. The cowl flaps should be opened, if necessary, to maintain the cylinder head temperature at approximately two-thirds of the normal operating range (green arc).

Cruise performance data in this handbook and on the power computer is based on a recommended lean mixture setting which may be established as follows:

- (1) Pull mixture control out slowly until engine becomes rough.
- (2) Push the mixture control in slightly to obtain smooth engine operation; then further enrichen an equal amount.

For best fuel economy at 65% power or less, the engine may be operated at the leanest mixture that results in smooth engine operation. This can result in approximately 10 percent greater range than shown in the cruise tables of this handbook accompanied by approximately a 6 knot decrease in speed.

Any change in altitude, power or carburetor heat will require a change in the recommended lean mixture setting and a recheck of the EGT setting (if installed).

Carburetor ice, as evidenced by an unexplained drop in manifold pressure, can be removed by application of full carburetor heat. Upon regaining the original manifold pressure indication (with heat off), use the minimum amount of heat (by trial and error) to prevent ice from forming. Since heated air causes a richer mixture, readjust the mixture setting when carburetor heat is used continuously in cruising flight.

ALTITUDE	75% POWER		65% POWER		55% POWER	
	KTAS	NMPG	KTAS	NMPG	KTAS	NMPG
3000 Feet	140	10.0	132	11.0	122	11.8
6500 Feet	144	10.4	136	11.4	125	12.1
10,000 Feet	---	---	140	11.7	128	12.4
Standard Conditions					Zero Wind	

Figure 4-3. Cruise Performance Table

The use of full carburetor heat is recommended during flight in very heavy rain to avoid the possibility of engine stoppage due to excessive water ingestion. The mixture setting should be readjusted for smoothest operation.

**LEANING WITH A CESSNA ECONOMY MIXTURE INDICATOR (EGT)**

Exhaust gas temperature (EGT) as shown on the optional Cessna Economy Mixture Indicator may be used as an aid for mixture leaning in cruising flight at 75% power or less. To adjust the mixture, using this indicator, lean to establish the peak EGT as a reference point and then enrichen the mixture by a desired increment based on figures in the table below.

Continuous operation at peak EGT is authorized only at 65% power or less. This best economy mixture setting results in approximately 10% greater range than shown in the cruise tables of this handbook accompanied by approximately a 6 knot decrease in speed.

**NOTE**

Operation on the lean side of peak EGT is not approved.

When leaning the mixture under some conditions, engine roughness may occur before peak EGT is reached. In this case, use the EGT corresponding to the onset of roughness as the reference point instead of peak EGT.

MIXTURE DESCRIPTION	EXHAUST GAS TEMPERATURE
RECOMMENDED LEAN (Pilots Operating Handbook and Power Computer)	Peak EGT Minus 75°F (Enrichen)
BEST ECONOMY (65% Power or Less)	Peak EGT

Figure 4-4. EGT Table

**STALLS**

The stall characteristics are conventional and aural warning is provided by a stall warning horn which sounds between 5 and 10 knots above the stall in all configurations.

Power-off stall speeds at maximum weight for both forward and aft c. g. positions are presented in Section 5.

## LANDING

### NORMAL LANDING

Landings should be made on the main wheels first to reduce the landing speed and the subsequent need for braking in the landing roll. The nose wheel is lowered gently to the runway after the speed has diminished to avoid unnecessary nose gear load. This procedure is especially important in rough field landings.

### SHORT FIELD LANDING

For short field landings, make a power-off approach at 60 KIAS with 40° flaps and land on the main wheels first. Immediately after touchdown, lower the nose gear to the ground and apply heavy braking as required. For maximum brake effectiveness after all three wheels are on the ground, retract the flaps, hold full nose up elevator and apply maximum possible brake pressure without sliding the tires.

### CROSSWIND LANDING

When landing in a strong crosswind, use the minimum flap setting required for the field length. Although the crab or combination method of drift correction may be used, the wing-low method gives the best control. After touchdown, hold a straight course with the steerable nose wheel and occasional braking if necessary.

### BALKED LANDING

In a bailed landing (go-around) climb, the wing flap setting should be reduced to 20° immediately after full power is applied. After all obstacles are cleared and a safe altitude and airspeed are obtained, the wing flaps should be retracted.

## COLD WEATHER OPERATION

### STARTING

Prior to starting on a cold morning, it is advisable to pull the propel-

ler through several times by hand to "break loose" or "limber" the oil, thus conserving battery energy.

NOTE

When pulling the propeller through by hand, treat it as if the ignition switch is turned on. A loose or broken ground wire on either magneto could cause the engine to fire.

In extremely cold (-18°C and lower) weather, the use of an external pre-heater and an external power source are recommended whenever possible to obtain positive starting and to reduce wear and abuse to the engine and the electrical system. Pre-heat will thaw the oil trapped in the oil cooler, which probably will be congealed prior to starting in extremely cold temperatures. When using an external power source, the position of the master switch is important. Refer to Section 7, paragraph Ground Service Plug Receptacle, for operating details.

Cold weather starting procedures are as follows:

With Preheat:

- (1) With ignition switch turned off, mixture full rich and throttle open 1/2 inch, prime the engine four to eight strokes as the propeller is being turned over by hand.

NOTE

Use heavy strokes of the primer for best atomization of fuel. After priming, push primer all the way in and turn to the locked position to avoid the possibility of the engine drawing fuel through the primer.

- (2) Propeller -- CLEAR.
- (3) Master Switch -- ON.
- (4) Ignition Switch -- START (release to BOTH when engine starts).
- (5) Pull carburetor heat on after engine has started, and leave on until the engine is running smoothly.

Without Preheat:

- (1) Prime the engine six to eight strokes while the propeller is being turned by hand with mixture full rich and throttle open 1/2 inch. Leave the primer charged and ready for stroke.
- (2) Propeller -- CLEAR.
- (3) Master Switch -- ON.

- (4) Ignition Switch -- START.
- (5) Pump throttle rapidly to full open twice. Return to 1/2 inch open position.
- (6) Release ignition switch to BOTH when engine starts.
- (7) Continue to prime the engine until it is running smoothly, or alternately, pump the throttle rapidly over the first 1/4 of total travel.
- (8) Oil Pressure -- CHECK.
- (9) Pull carburetor heat on after engine has started. Leave on until the engine is running smoothly.
- (10) Primer -- LOCK.

NOTE

If the engine does not start during the first few attempts, or if engine firing diminishes in strength, it is probable that the spark plugs have been frosted over. Preheat must be used before another start is attempted.

**CAUTION**

Pumping the throttle may cause raw fuel to accumulate in the intake air duct, creating a fire hazard in the event of a backfire. If this occurs, maintain a cranking action to suck the flames into the engine. An outside attendant with a fire extinguisher is advised for cold starts without preheat.

**OPERATION**

During cold weather operations, no indication will be apparent on the oil temperature gage prior to takeoff if outside air temperatures are very cold. After a suitable warm-up period (2 to 5 minutes at 1000 RPM), accelerate the engine several times to higher engine RPM. If the engine accelerates smoothly and the oil pressure remains normal and steady, the airplane is ready for takeoff.

Rough engine operation in cold weather can be caused by a combination of an inherently leaner mixture due to the dense air and poor vaporization and distribution of the fuel-air mixture to the cylinders. The effects of these conditions are especially noticeable during operation on one magneto in ground checks where only one spark plug fires in each cylinder.

For optimum operation of the engine in cold weather, the appropriate use of carburetor heat is recommended. The following procedures are indicated as a guideline:

- (1) Use carburetor heat during engine warm-up and ground check.

Full carburetor heat may be required for temperatures below  $-12^{\circ}\text{C}$  whereas partial heat could be used in temperatures between  $-12^{\circ}\text{C}$  and  $4^{\circ}\text{C}$ .

(2) Use the minimum carburetor heat required for smooth operation in take-off, climb, and cruise.

#### NOTE

Care should be exercised when using partial carburetor heat to avoid icing. Partial heat may raise the carburetor or air temperature to  $0^{\circ}\text{C}$  to  $21^{\circ}\text{C}$  range where icing is critical under certain atmospheric conditions.

(3) If the airplane is equipped with a carburetor air temperature gage, it can be used as a reference in maintaining carburetor air temperature at or slightly above the top of the yellow arc by application of carburetor heat.

## HOT WEATHER OPERATION

The general warm temperature starting information in this section is appropriate. Avoid prolonged engine operation on the ground.

## NOISE ABATEMENT

Increased emphasis on improving the quality of our environment requires renewed effort on the part of all pilots to minimize the effect of airplane noise on the public.

We, as pilots, can demonstrate our concern for environmental improvement, by application of the following suggested procedures, and thereby tend to build public support for aviation:

- (1) Pilots operating aircraft under VFR over outdoor assemblies of persons, recreational and park areas, and other noise-sensitive areas should make every effort to fly not less than 2000 feet above the surface, weather permitting, even though flight at a lower level may be consistent with the provisions of government regulations.
- (2) During departure from or approach to an airport, climb after takeoff and descent for landing should be made so as to avoid prolonged flight at low altitude near noise-sensitive areas.

NOTE

The above recommended procedures do not apply where they would conflict with Air Traffic Control clearances or instructions, or where, in the pilot's judgment, an altitude of less than 2000 feet is necessary for him to adequately exercise his duty to see and avoid other aircraft.



# SECTION 5 PERFORMANCE

## TABLE OF CONTENTS

	Page
Introduction . . . . .	5-3
Use of Performance Charts . . . . .	5-3
Sample Problem . . . . .	5-3
Takeoff . . . . .	5-4
Cruise . . . . .	5-5
Fuel Required . . . . .	5-5
Landing . . . . .	5-7
Figure 5-1, Airspeed Calibration - Normal Static Source . . . . .	5-8
Airspeed Calibration - Alternate Static Source . . . . .	5-9
Figure 5-2, Temperature Conversion Chart . . . . .	5-10
Figure 5-3, Stall Speeds . . . . .	5-11
Figure 5-4, Takeoff Distance - 2950 Lbs . . . . .	5-12
Takeoff Distance - 2700 Lbs and 2400 Lbs . . . . .	5-13
Figure 5-5, Rate of Climb. . . . .	5-14
Figure 5-6, Time, Fuel, and Distance to Climb - Maximum Rate of Climb . . . . .	5-15
Time, Fuel, and Distance to Climb - Normal Climb. . . . .	5-16
Figure 5-7, Cruise Performance - 2000 Feet . . . . .	5-17
Cruise Performance - 4000 Feet . . . . .	5-18
Cruise Performance - 6000 Feet . . . . .	5-19
Cruise Performance - 8000 Feet . . . . .	5-20
Cruise Performance - 10,000 Feet . . . . .	5-21
Cruise Performance - 12,000 Feet . . . . .	5-22
Figure 5-8, Range Profile - 56 Gallons Fuel . . . . .	5-23
Range Profile - 75 Gallons Fuel . . . . .	5-24
Figure 5-9, Endurance Profile - 56 Gallons Fuel . . . . .	5-25
Endurance Profile - 75 Gallons Fuel . . . . .	5-26
Figure 5-10, Landing Distance . . . . .	5-27

5-1/(5-2 blank)



## INTRODUCTION

Performance data charts on the following pages are presented so that you may know what to expect from the airplane under various conditions, and also, to facilitate the planning of flights in detail and with reasonable accuracy. The data in the charts has been computed from actual flight tests with the airplane and engine in good condition and using average piloting techniques.

It should be noted that the performance information presented in the range and endurance profile charts allows for 45 minutes reserve fuel based on 45% power. Fuel flow data for cruise is based on the recommended lean mixture setting. Some indeterminate variables such as mixture leaning technique, fuel metering characteristics, engine and propeller condition, and air turbulence may account for variations of 10% or more in range and endurance. Therefore, it is important to utilize all available information to estimate the fuel required for the particular flight.

## USE OF PERFORMANCE CHARTS

Performance data is presented in tabular or graphical form to illustrate the effect of different variables. Sufficiently detailed information is provided in the tables so that conservative values can be selected and used to determine the particular performance figure with reasonable accuracy.

## SAMPLE PROBLEM

The following sample flight problem utilizes information from the various charts to determine the predicted performance data for a typical flight. The following information is known:

### AIRPLANE CONFIGURATION

Takeoff weight	2850 Pounds
Usable fuel	75 Gallons

### TAKEOFF CONDITIONS

Field pressure altitude	1500 Feet
Temperature	28°C (16°C above standard)
Wind component along runway	12 Knot Headwind
Field length	3500 Feet

SECTION 5  
PERFORMANCE

CESSNA  
MODEL 182P

CRUISE CONDITIONS

Total distance	675 Nautical Miles
Pressure altitude	7500 Feet
Temperature	16°C (16°C above standard)
Expected wind enroute	10 Knot Headwind

LANDING CONDITIONS

Field pressure altitude	2000 Feet
Temperature	25°C
Wind component along runway	6 Knot Headwind
Field length	3000 Feet

TAKEOFF

The takeoff distance chart, figure 5-4, should be consulted, keeping in mind that the distances shown are based on maximum performance techniques. Conservative distances can be established by reading the chart at the next higher value of weight, altitude and temperature. For example, in this particular sample problem, the takeoff distance information presented for a weight of 2950 lbs., a pressure altitude of 2000 feet and a temperature of 30°C should be used and results in the following:

Ground roll	930 Feet
Total distance to clear a 50-foot obstacle	1800 Feet

A correction for the effect of wind may be made based on Note 3 of the takeoff chart. The distance correction for a 12 knot headwind is:

$$\frac{12 \text{ Knots}}{9 \text{ Knots}} \times 10\% = 13\% \text{ Decrease}$$

This results in the following distances, corrected for wind:

Ground roll, zero wind	930
Decrease in ground roll (930 feet x 13%)	<u>121</u>
Corrected ground roll	809 Feet
Total distance to clear a 50-foot obstacle, zero wind	1800
Decrease in total distance (1800 feet x 13%)	<u>234</u>
Corrected total distance to clear 50-foot obstacle	1566 Feet

These distances are well within the takeoff field length quoted earlier for the sample problem.

**CRUISE**

The cruising altitude and winds aloft information have been given for this flight. However, the power setting selection for cruise must be determined based on several considerations. These include the cruise performance characteristics of the airplane presented in figure 5-7, the range profile chart presented in figure 5-8, and the endurance profile chart presented in figure 5-9.

The range profile chart illustrates the relationship between power and range. Considerable fuel savings and longer range result when lower power settings are used.

For this sample problem, with a cruise altitude of 7500 feet, the range profile chart indicates that use of a 65% power setting yields a predicted range of 733 nautical miles under zero wind conditions. The endurance profile chart, figure 5-9, shows a corresponding 5.4 hours and, using this information, the estimated distance can be determined for the expected 10 knot headwind at 7500 feet as follows:

Range, zero wind	733
Decrease in range due to wind (5.4 hours x 10 knot headwind)	54
Corrected range	<u>679</u> Nautical Miles

This indicates that the trip can be made without a fuel stop using approximately 65% power.

The cruise performance chart for 8000 feet pressure altitude (figure 5-7, sheet 4) is entered using 20°C above standard temperature. These values most nearly correspond to the expected altitude and temperature conditions. The power setting chosen is 2400 RPM and 20 inches of manifold pressure, which results in the following:

Power	63%
True airspeed	138 Knots
Cruise fuel flow	11.6 GPH

The power computer may be used to determine power and fuel consumption during flight.

**FUEL REQUIRED**

The total fuel requirement for the flight may be estimated using the performance information in figures 5-6 and 5-7. For this sample problem, figure 5-6 (using normal climb) shows that a climb from 2000 feet to

SECTION 5  
PERFORMANCE

CESSNA  
MODEL 182P

8000 feet requires 3.6 gallons of fuel. The corresponding distance during the climb is 20 nautical miles. These values are for a standard temperature (as shown on the climb chart). The approximate effect of a non-standard temperature is to increase the time, fuel, and distance by 10% for each 10°C above standard temperature, due to the lower rate of climb. In this case, assuming a temperature 16°C above standard, the correction would be:

$$\frac{16^{\circ}\text{C}}{10^{\circ}\text{C}} \times 10\% = 16\% \text{ Increase}$$

With this factor included, the fuel estimate would be calculated as follows:

Fuel to climb, standard temperature	3.6
Increase due to non-standard temperature (3.6 x 16%)	0.6
Corrected fuel to climb	<u>4.2</u> Gallons

In addition, the distance may be corrected for the non-standard temperature as follows:

Distance to climb, standard temperature	20
Increase due to non-standard temperature (20 nautical miles x 16%)	3
Corrected distance to climb	<u>23</u> Nautical Miles

The resultant cruise distance is:

Total distance	675
Climb distance	-23
Cruise distance	<u>652</u> Nautical Miles

With an expected 10 knot headwind, the ground speed for cruise is predicted to be:

$$\begin{array}{r} 138 \\ -10 \\ \hline 128 \text{ Knots} \end{array}$$

Therefore, the time required for the cruise portion of the trip is:

$$\frac{652 \text{ Nautical Miles}}{128 \text{ Knots}} = 5.1 \text{ Hours}$$

The fuel required for cruise is endurance times fuel consumption:

$$5.1 \text{ hours} \times 11.6 \text{ gallons/hour} = 59.2 \text{ Gallons}$$

The total estimated fuel required is as follows:

Engine start, taxi, and takeoff	1.8
Climb	4.2
Cruise	59.2
Total fuel required	<u>65.2</u> Gallons

This will leave a fuel reserve of:

75.0
<u>-65.2</u>
9.8 Gallons

Once the flight is underway, ground speed checks will provide a more accurate basis for estimating the time enroute and the corresponding fuel required to complete the trip with ample reserve.

### LANDING

A procedure similar to the takeoff calculations should be used for estimating the landing distance at the destination airport. Figure 5-10 presents maximum performance technique landing distances for various airport altitude and temperature combinations. The distances corresponding to 2000 feet altitude and 30°C should be used and result in the following:

Ground roll	670 Feet
Total distance to clear a 50-foot obstacle	1480 Feet

A correction for wind may be made based on Note 2 of the landing chart. The distance correction for a 6 knot headwind is:

$$\frac{6 \text{ Knots}}{9 \text{ Knots}} \times 10\% = 7\% \text{ Decrease}$$

This results in the following wind-corrected figures:

Ground roll	623 Feet
Total distance over a 50-foot obstacle	1376 Feet

These distances are well within the landing field length quoted previously for this sample problem.

**AIRSPEED CALIBRATION**  
**NORMAL STATIC SOURCE**

FLAPS UP													
KIAS	50	60	70	80	90	100	110	120	130	140	150	160	---
KCAS	57	64	72	80	90	99	109	118	128	138	147	157	---
FLAPS 20°													
KIAS	40	50	60	70	80	90	95	---	---	---	---	---	---
KCAS	51	57	64	72	80	90	95	---	---	---	---	---	---
FLAPS 40°													
KIAS	40	50	60	70	80	90	95	---	---	---	---	---	---
KCAS	50	56	64	72	81	90	95	---	---	---	---	---	---

Figure 5-1. Airspeed Calibration (Sheet 1 of 2)



**AIRSPEED CALIBRATION  
ALTERNATE STATIC SOURCE**

**HEATER/VENTS AND WINDOWS CLOSED**

<b>FLAPS UP</b>											
NORMAL KIAS	60	70	80	90	100	110	120	130	140	150	160
ALTERNATE KIAS	63	74	84	94	104	114	124	134	144	154	164
<b>FLAPS 20°</b>											
NORMAL KIAS	50	60	70	80	90	95	---	---	---	---	---
ALTERNATE KIAS	53	63	74	83	93	97	---	---	---	---	---
<b>FLAPS 40°</b>											
NORMAL KIAS	40	50	60	70	80	90	95	---	---	---	---
ALTERNATE KIAS	41	52	62	73	83	93	97	---	---	---	---

**HEATER/VENTS OPEN AND WINDOWS CLOSED**

<b>FLAPS UP</b>											
NORMAL KIAS	60	70	80	90	100	110	120	130	140	150	160
ALTERNATE KIAS	61	71	81	90	100	110	120	130	140	150	160
<b>FLAPS 20°</b>											
NORMAL KIAS	50	60	70	80	90	95	---	---	---	---	---
ALTERNATE KIAS	51	61	70	80	90	95	---	---	---	---	---
<b>FLAPS 40°</b>											
NORMAL KIAS	40	50	60	70	80	90	95	---	---	---	---
ALTERNATE KIAS	39	49	59	69	79	90	95	---	---	---	---

**WINDOWS OPEN**

<b>FLAPS UP</b>											
NORMAL KIAS	60	70	80	90	100	110	120	130	140	150	160
ALTERNATE KIAS	52	67	81	93	105	115	126	137	148	159	170
<b>FLAPS 20°</b>											
NORMAL KIAS	50	60	70	80	90	95	---	---	---	---	---
ALTERNATE KIAS	40	55	68	79	91	96	---	---	---	---	---
<b>FLAPS 40°</b>											
NORMAL KIAS	50	60	70	80	90	95	---	---	---	---	---
ALTERNATE KIAS	40	55	67	78	89	94	---	---	---	---	---

Figure 5-1. Airspeed Calibration (Sheet 2 of 2)

### TEMPERATURE CONVERSION CHART

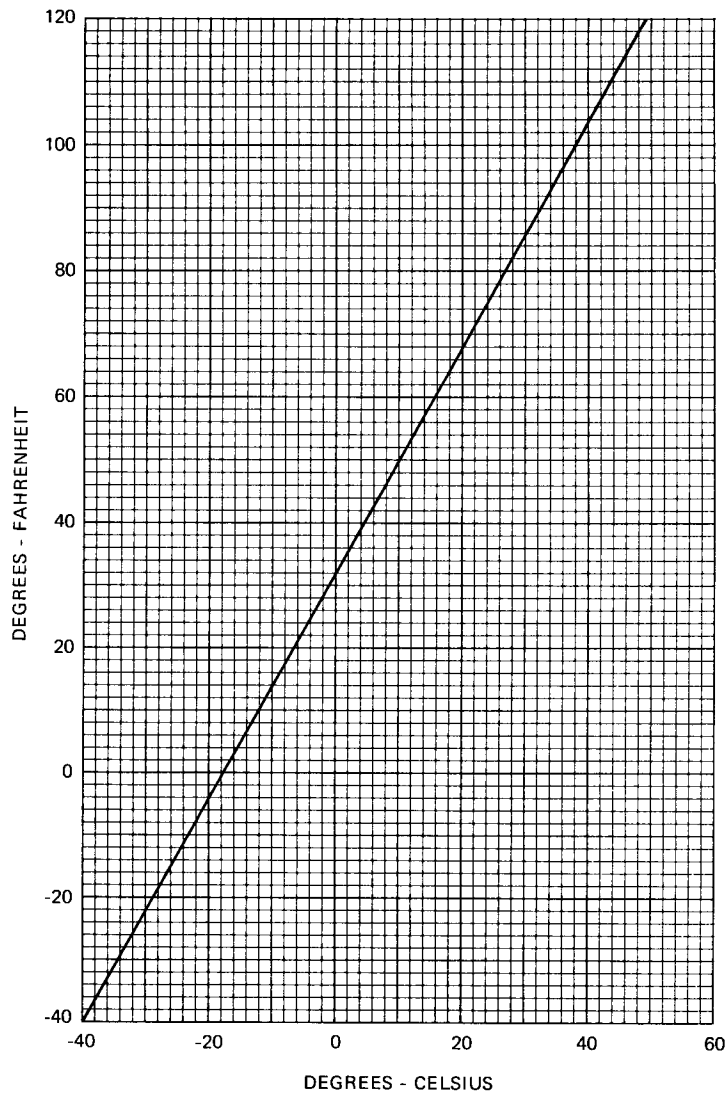

Figure 5-2. Temperature Conversion Chart

## STALL SPEEDS

CONDITIONS:  
Power Off

NOTES:

1. Maximum altitude loss during a stall recovery is approximately 160 feet.
2. KIAS values are approximate.

### MOST REARWARD CENTER OF GRAVITY

WEIGHT LBS	FLAP DEFLECTION	ANGLE OF BANK							
		0°		30°		45°		60°	
		KIAS	KCAS	KIAS	KCAS	KIAS	KCAS	KIAS	KCAS
2950	UP	48	56	52	60	57	67	68	79
	20°	40	51	43	55	48	61	57	72
	40°	40	50	43	54	48	59	57	71

### MOST FORWARD CENTER OF GRAVITY

WEIGHT LBS	FLAP DEFLECTION	ANGLE OF BANK							
		0°		30°		45°		60°	
		KIAS	KCAS	KIAS	KCAS	KIAS	KCAS	KIAS	KCAS
2950	UP	53	59	57	63	63	70	75	83
	20°	48	55	52	59	57	65	68	78
	40°	48	54	52	58	57	64	68	76

Figure 5-3. Stall Speeds

**TAKEOFF DISTANCE**  
**MAXIMUM WEIGHT 2950 LBS**

**CONDITIONS:**

Flaps 20°  
2600 RPM and Full Throttle Prior to Brake Release  
Cowl Flaps Open  
Paved, Level, Dry Runway  
Zero Wind

**NOTES:**

1. Maximum performance technique as specified in Section 4.
2. Prior to takeoff from fields above 5000 feet elevation, the mixture should be leaned to give maximum power in a full throttle, static runup.
3. Decrease distances 10% for each 9 knots headwind. For operation with tailwinds up to 10 knots, increase distances by 10% for each 2 knots.
4. Where distance value has been deleted, climb performance after lift-off is less than 150 fpm at takeoff speed.
5. For operation on a dry, grass runway, increase distances by 15% of the "ground roll" figure.

WEIGHT LBS	TAKEOFF SPEED KIAS		PRESS ALT FT	0°C			10°C			20°C			30°C			40°C		
	LIFT OFF	AT 50 FT		GRND ROLL	TO CLEAR 50 FT OBS	TOTAL	GRND ROLL	TO CLEAR 50 FT OBS	TOTAL	GRND ROLL	TO CLEAR 50 FT OBS	TOTAL	GRND ROLL	TO CLEAR 50 FT OBS	TOTAL	GRND ROLL	TO CLEAR 50 FT OBS	TOTAL
2950	49	57	S.L.	635	1220	1305	680	1430	1395	730	1395	780	1490	1490	835	1590		
			1000	690	1335	745	1530	795	1530	850	1635	850	1635	910	1745			
	2000	755	1465	810	1680	870	1680	930	1800	930	1800	995	1925					
	3000	825	1605	890	1725	950	1850	1020	1985	1020	1985	1090	2130					
	4000	905	1770	970	1905	1045	2050	1120	2205	1120	2205	1195	2370					
	5000	995	1965	1065	2115	1145	2280	1230	2460	1230	2460	1315	2655					
	6000	1090	2185	1175	2360	1260	2555	1350	2765	1350	2765	1450	3005					
	7000	1200	2450	1290	2655	1390	2885	1490	3145	1490	3145	---	---					
	8000	1325	2765	1425	3015	1530	3300	---	---	---	---	---	---					

Figure 5-4. Takeoff Distance (Sheet 1 of 2)

**TAKEOFF DISTANCE**  
2700 LBS AND 2400 LBS

REFER TO SHEET 1 FOR APPROPRIATE CONDITIONS AND NOTES.

WEIGHT LBS	TAKEOFF SPEED KIAS		PRESS ALT FT	0°C		10°C		20°C		30°C		40°C	
	LIFT OFF	AT 50 FT		GRND ROLL	TOTAL TO CLEAR 50 FT OBS	GRND ROLL	TOTAL TO CLEAR 50 FT OBS	GRND ROLL	TOTAL TO CLEAR 50 FT OBS	GRND ROLL	TOTAL TO CLEAR 50 FT OBS	GRND ROLL	TOTAL TO CLEAR 50 FT OBS
2700	47	55	S.L.	520	1000	555	1065	595	1135	635	1210	680	1285
			1000	565	1085	1160	650	1235	695	1320	740	1405	
	2000	615	1185	1265	710	1355	760	1445	810	1540			
	3000	675	1295	1385	775	1485	830	1585	885	1695			
	4000	735	1425	1525	850	1630	910	1745	970	1870			
	5000	805	1565	1680	930	1800	995	1930	1065	2075			
	6000	885	1730	1860	1020	1995	1095	2150	1170	2310			
	7000	970	1920	2065	1120	2225	1205	2400	1290	2595			
	8000	1070	2140	2310	1235	2500	1325	2705	1420	2935			
	2400	44	52	S.L.	395	775	425	825	455	875	485	930	520
1000				430	840	465	895	495	950	530	1010	565	1075
2000		470	915	505	975	540	1035	575	1105	615	1175		
3000		515	995	550	1060	590	1130	630	1205	675	1285		
4000		560	1085	600	1160	645	1235	690	1320	735	1405		
5000		615	1185	655	1270	705	1355	755	1445	805	1545		
6000		670	1300	720	1395	770	1490	825	1595	885	1705		
7000		735	1435	790	1535	845	1645	905	1765	970	1890		
8000		810	1585	870	1700	930	1825	1000	1960	1070	2105		

Figure 5-4. Takeoff Distance (Sheet 2 of 2)

## RATE OF CLIMB

CONDITIONS:  
Flaps Up  
2600 RPM  
Full Throttle  
Cowl Flaps Open

NOTE:  
Mixture leaned above 5000 feet for maximum power.

WEIGHT LBS	PRESS ALT FT	CLIMB SPEED KIAS	RATE OF CLIMB - FPM			
			-20°C	0°C	20°C	40°C
2950	S.L.	80	1040	955	870	785
	2000	79	930	845	765	685
	4000	78	820	740	660	585
	6000	76	710	635	560	485
	8000	74	600	530	460	390
	10,000	73	495	425	360	---
	12,000	71	390	325	265	---

Figure 5-5. Rate of Climb

## TIME, FUEL, AND DISTANCE TO CLIMB MAXIMUM RATE OF CLIMB

CONDITIONS:  
Flaps Up  
2600 RPM  
Full Throttle  
Cowl Flaps Open  
Standard Temperature

- NOTES:
1. Add 1.8 gallons of fuel for engine start, taxi and takeoff allowance.
  2. Mixture leaned above 5000 feet for maximum power.
  3. Increase time, fuel and distance by 10% for each 10°C above standard temperature.
  4. Distances shown are based on zero wind.

WEIGHT LBS	PRESSURE ALTITUDE FT	TEMP °C	CLIMB SPEED KIAS	RATE OF CLIMB FPM	FROM SEA LEVEL		
					TIME MIN	FUEL USED GALLONS	DISTANCE NM
2950	S.L.	15	80	890	0	0	0
	1000	13	80	845	1	0.4	2
	2000	11	79	800	2	0.9	3
	3000	9	78	755	4	1.3	5
	4000	7	78	710	5	1.8	7
	5000	5	77	665	7	2.3	9
	6000	3	76	620	8	2.8	11
	7000	1	75	575	10	3.3	13
	8000	-1	75	535	12	3.9	16
	9000	-3	74	490	14	4.5	19
	10,000	-5	73	445	16	5.2	22
	11,000	-7	73	400	18	5.9	25
12,000	-9	72	355	21	6.6	29	

Figure 5-6. Time, Fuel, and Distance to Climb (Sheet 1 of 2)

**TIME, FUEL, AND DISTANCE TO CLIMB**  
**NORMAL CLIMB - 90 KIAS**

CONDITIONS:

Flaps Up  
2450 RPM  
23 Inches MP or Full Throttle  
Cowl Flaps Open  
Standard Temperature

NOTES:

1. Add 1.8 gallons of fuel for engine start, taxi and takeoff allowance.
2. Mixture leaned above 5000 feet for best power.
3. Increase time, fuel and distance by 10% for each 10°C above standard temperature.
4. Distances shown are based on zero wind.

WEIGHT LBS	PRESSURE ALTITUDE FT	TEMP °C	RATE OF CLIMB FPM	FROM SEA LEVEL		
				TIME MIN	FUEL USED GALLONS	DISTANCE NM
2950	S.L.	15	520	0	0	0
	1000	13	520	2	0.6	3
	2000	11	520	4	1.2	6
	3000	9	520	6	1.7	9
	4000	7	520	8	2.3	12
	5000	5	520	10	2.9	15
	6000	3	495	12	3.5	18
	7000	1	445	14	4.1	22
	8000	-1	395	16	4.8	26
	9000	-3	350	19	5.5	31
	10,000	-5	300	22	6.4	36
	11,000	-7	250	26	7.4	43
12,000	-9	200	30	8.5	51	

Figure 5-6. Time, Fuel, and Distance to Climb (Sheet 2 of 2)



**CRUISE PERFORMANCE**  
**PRESSURE ALTITUDE 2000 FEET**

CONDITIONS:  
Recommended Lean Mixture  
2950 Pounds  
Cowl Flaps Closed

		20°C BELOW STANDARD TEMP -9°C			STANDARD TEMPERATURE 11°C			20°C ABOVE STANDARD TEMP 31°C		
RPM	MP	% BHP	KTAS	GPH	% BHP	KTAS	GPH	% BHP	KTAS	GPH
2450	23	---	---	---	76	139	14.1	73	140	13.6
	22	75	135	13.8	72	136	13.3	70	137	12.8
	21	70	132	13.0	68	133	12.5	66	134	12.1
	20	66	129	12.2	64	130	11.8	62	130	11.4
2400	23	77	136	14.3	74	138	13.7	72	139	13.3
	22	73	134	13.5	70	135	13.0	68	136	12.6
	21	69	131	12.7	66	132	12.3	64	133	11.9
	20	65	128	12.0	62	129	11.6	60	129	11.2
2300	23	73	134	13.5	70	135	13.0	68	136	12.5
	22	69	131	12.7	67	132	12.3	64	133	11.9
	21	65	128	12.0	63	129	11.6	61	129	11.3
	20	61	125	11.3	59	125	11.0	57	125	10.6
2200	23	68	130	12.5	66	131	12.1	63	132	11.7
	22	64	127	11.9	62	128	11.5	60	129	11.1
	21	60	124	11.2	58	125	10.9	56	125	10.5
	20	56	120	10.6	54	121	10.2	52	120	10.0
	19	52	116	9.9	50	116	9.6	49	115	9.4
	18	48	111	9.3	47	111	9.0	45	109	8.8
17	44	106	8.6	43	104	8.4	41	103	8.2	

Figure 5-7. Cruise Performance (Sheet 1 of 6)

**CRUISE PERFORMANCE**  
**PRESSURE ALTITUDE 4000 FEET**

CONDITIONS:  
Recommended Lean Mixture  
2950 Pounds  
Cowl Flaps Closed

		20°C BELOW STANDARD TEMP -13°C			STANDARD TEMPERATURE 7°C			20°C ABOVE STANDARD TEMP 27°C		
RPM	MP	% BHP	KTAS	GPH	% BHP	KTAS	GPH	% BHP	KTAS	GPH
2450	23	---	---	---	77	142	14.2	74	143	13.7
	22	75	138	14.0	73	139	13.4	70	140	13.0
	21	71	135	13.1	69	136	12.7	66	137	12.3
	20	67	132	12.4	65	133	11.9	62	133	11.6
2400	23	78	139	14.5	75	141	13.9	72	142	13.4
	22	74	137	13.6	71	138	13.1	69	139	12.7
	21	70	134	12.9	67	135	12.4	65	136	12.0
	20	66	131	12.1	63	132	11.7	61	132	11.4
2300	23	74	137	13.6	71	138	13.1	69	139	12.7
	22	70	134	12.9	67	135	12.5	65	136	12.1
	21	66	131	12.2	64	132	11.8	62	133	11.4
	20	62	128	11.5	60	128	11.1	58	128	10.8
2200	23	69	134	12.8	67	135	12.3	65	135	11.9
	22	65	131	12.1	63	131	11.7	61	132	11.3
	21	62	127	11.4	59	128	11.1	57	128	10.7
	20	58	124	10.8	56	124	10.4	54	123	10.1
	19	54	119	10.1	52	119	9.8	50	118	9.6
	18	50	115	9.5	48	114	9.2	46	112	9.0
	17	46	109	8.9	44	107	8.6	43	106	8.4

Figure 5-7. Cruise Performance (Sheet 2 of 6)

**CRUISE PERFORMANCE**  
**PRESSURE ALTITUDE 6000 FEET**

CONDITIONS:  
Recommended Lean Mixture  
2950 Pounds  
Cowl Flaps Closed

		20°C BELOW STANDARD TEMP -17°C			STANDARD TEMPERATURE 3°C			20°C ABOVE STANDARD TEMP 23°C		
RPM	MP	% BHP	KTAS	GPH	% BHP	KTAS	GPH	% BHP	KTAS	GPH
2450	23	---	---	---	77	145	14.3	75	146	13.8
	22	76	141	14.1	73	142	13.6	71	143	13.1
	21	72	138	13.3	69	139	12.8	67	140	12.4
	20	68	135	12.5	65	136	12.1	63	136	11.7
2400	23	---	---	---	76	144	14.0	73	145	13.5
	22	75	140	13.8	72	141	13.3	69	142	12.8
	21	71	137	13.0	68	138	12.6	66	139	12.1
	20	67	134	12.3	64	135	11.9	62	135	11.5
2300	23	75	140	13.8	72	141	13.3	70	142	12.8
	22	71	137	13.1	68	138	12.6	66	139	12.2
	21	67	134	12.4	65	135	12.0	63	136	11.6
	20	63	131	11.7	61	132	11.3	59	132	11.0
2200	23	71	137	13.0	68	138	12.6	66	139	12.1
	22	67	134	12.3	64	135	11.9	62	135	11.5
	21	63	131	11.7	61	131	11.3	59	131	10.9
	20	59	127	11.0	57	127	10.6	55	127	10.3
	19	55	123	10.4	53	122	10.0	51	121	9.7
	18	51	118	9.7	49	117	9.4	48	115	9.2
	17	47	112	9.1	45	110	8.8	44	109	8.5

Figure 5-7. Cruise Performance (Sheet 3 of 6)

**CRUISE PERFORMANCE**  
**PRESSURE ALTITUDE 8000 FEET**

CONDITIONS:  
Recommended Lean Mixture  
2950 Pounds  
Cowl Flaps Closed

		20°C BELOW STANDARD TEMP -21°C			STANDARD TEMPERATURE -1°C			20°C ABOVE STANDARD TEMP 19°C		
RPM	MP	% BHP	KTAS	GPH	% BHP	KTAS	GPH	% BHP	KTAS	GPH
2450	21	73	141	13.5	70	142	13.0	68	143	12.5
	20	69	138	12.7	66	139	12.3	64	139	11.9
	19	65	135	12.0	62	135	11.6	60	135	11.2
	18	60	131	11.2	58	131	10.9	56	130	10.5
2400	21	72	140	13.2	69	141	12.7	67	142	12.3
	20	68	137	12.5	65	138	12.0	63	138	11.6
	19	63	133	11.8	61	134	11.4	59	134	11.0
	18	59	129	11.0	57	129	10.7	55	129	10.4
2300	21	68	138	12.6	66	139	12.2	64	139	11.8
	20	64	134	11.9	62	135	11.5	60	135	11.2
	19	60	131	11.2	58	131	10.9	56	130	10.5
	18	56	126	10.6	54	126	10.2	52	125	9.9
2200	21	64	134	11.9	62	135	11.5	60	135	11.1
	20	60	130	11.2	58	130	10.8	56	130	10.5
	19	56	126	10.6	54	126	10.2	52	125	9.9
	18	52	121	9.9	50	120	9.6	49	119	9.3
	17	48	115	9.3	47	114	9.0	45	112	8.7
	16	44	108	8.6	43	106	8.4	41	103	8.1

Figure 5-7. Cruise Performance (Sheet 4 of 6)

**CRUISE PERFORMANCE**  
**PRESSURE ALTITUDE 10,000 FEET**

CONDITIONS:  
Recommended Lean Mixture  
2950 Pounds  
Cowl Flaps Closed

		20°C BELOW STANDARD TEMP -25°C			STANDARD TEMPERATURE -5°C			20°C ABOVE STANDARD TEMP 15°C		
RPM	MP	% BHP	KTAS	GPH	% BHP	KTAS	GPH	% BHP	KTAS	GPH
2450	20	70	142	12.9	67	142	12.4	65	143	12.0
	19	66	138	12.1	63	138	11.7	61	138	11.4
	18	62	134	11.4	59	134	11.0	57	133	10.7
	17	57	129	10.7	55	128	10.4	53	127	10.0
2400	20	69	140	12.6	66	141	12.2	64	141	11.8
	19	64	137	11.9	62	137	11.5	60	137	11.2
	18	60	132	11.2	58	132	10.9	56	132	10.5
	17	56	127	10.5	54	127	10.2	52	125	9.9
2300	20	66	138	12.1	63	138	11.7	61	138	11.3
	19	62	134	11.5	59	134	11.1	57	133	10.7
	18	58	129	10.8	55	129	10.4	53	128	10.1
	17	53	124	10.1	51	123	9.8	49	121	9.5
2200	20	62	134	11.4	59	134	11.1	57	133	10.7
	19	58	129	10.8	55	129	10.4	54	128	10.1
	18	54	125	10.1	52	123	9.8	50	122	9.5
	17	50	119	9.5	48	117	9.2	46	115	8.9
	16	46	112	8.8	44	109	8.5	42	106	8.3

Figure 5-7. Cruise Performance (Sheet 5 of 6)

**CRUISE PERFORMANCE**  
**PRESSURE ALTITUDE 12,000 FEET**

CONDITIONS:  
Recommended Lean Mixture  
2950 Pounds  
Cowl Flaps Closed

		20°C BELOW STANDARD TEMP -29°C			STANDARD TEMPERATURE -9°C			20°C ABOVE STANDARD TEMP 11°C		
RPM	MP	% BHP	KTAS	GPH	% BHP	KTAS	GPH	% BHP	KTAS	GPH
2450	18	63	137	11.6	60	137	11.2	58	136	10.9
	17	58	132	10.9	56	131	10.5	54	130	10.2
	16	54	126	10.2	52	125	9.8	50	123	9.5
	15	49	119	9.4	47	117	9.1	46	114	8.9
2400	18	61	136	11.4	59	135	11.0	57	135	10.7
	17	57	131	10.7	55	130	10.3	53	128	10.0
	16	53	125	10.0	51	123	9.7	49	121	9.4
	15	48	117	9.3	46	115	9.0	45	112	8.7
2300	18	59	133	11.0	57	132	10.6	55	131	10.3
	17	55	127	10.3	52	126	10.0	51	124	9.7
	16	50	121	9.6	48	119	9.3	47	116	9.0
	15	46	113	8.8	44	109	8.5	42	105	8.3
2200	18	55	128	10.4	53	127	10.0	51	125	9.7
	17	51	122	9.7	49	120	9.4	47	118	9.1
	16	47	115	9.0	45	112	8.7	43	109	8.5
	15	43	106	8.4	41	102	8.1	40	97	7.9

Figure 5-7. Cruise Performance (Sheet 6 of 6)

**RANGE PROFILE**  
**45 MINUTES RESERVE**  
**56 GALLONS USABLE FUEL**

CONDITIONS:  
2950 Pounds  
Recommended Lean Mixture for Cruise  
Standard Temperature  
Zero Wind

- NOTES:
1. This chart allows for the fuel used for engine start, taxi, takeoff and climb, and the distance during a normal climb as shown in figure 5-6 (sheet 2).
  2. Reserve fuel is based on 45 minutes at 45% BHP and is 6.5 gallons.

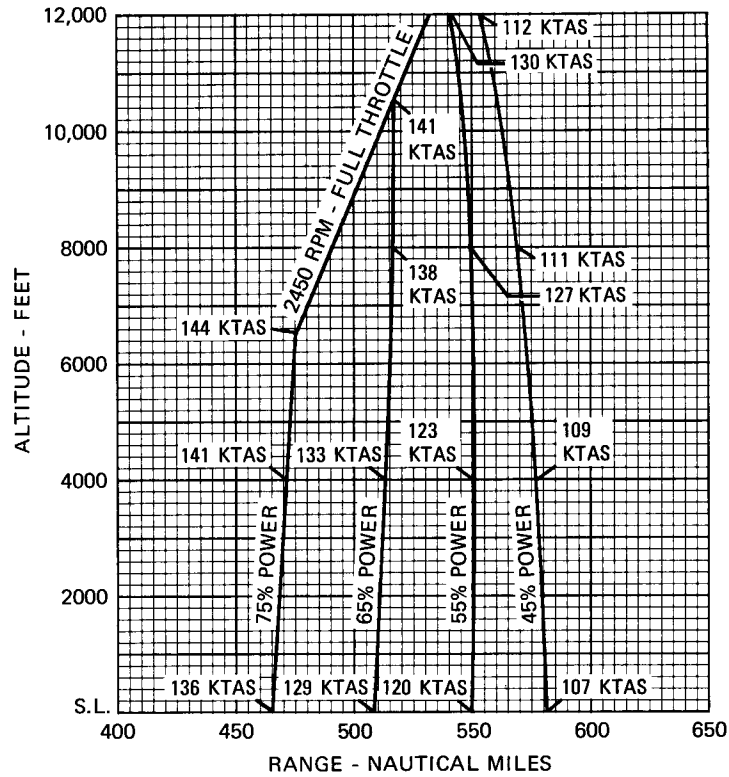

Figure 5-8. Range Profile (Sheet 1 of 2)

**RANGE PROFILE**  
**45 MINUTES RESERVE**  
**75 GALLONS USABLE FUEL**

**CONDITIONS:**

2950 Pounds  
Recommended Lean Mixture for Cruise  
Standard Temperature  
Zero Wind

**NOTES:**

1. This chart allows for the fuel used for engine start, taxi, takeoff and climb, and the distance during a normal climb as shown in figure 5-6 (sheet 2).
2. Reserve fuel is based on 45 minutes at 45% BHP and is 6.5 gallons.

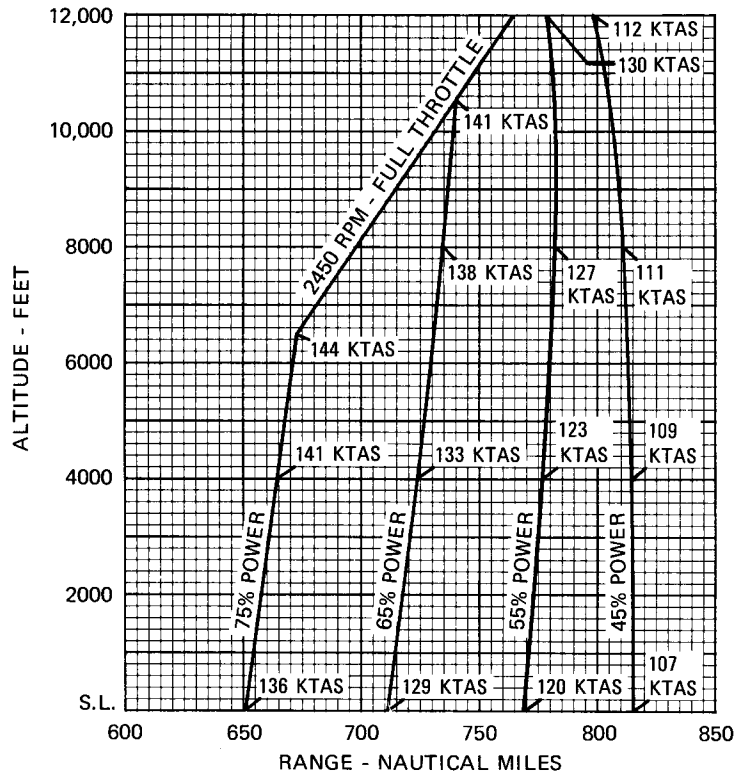

Figure 5-8. Range Profile (Sheet 2 of 2)



### ENDURANCE PROFILE 45 MINUTES RESERVE 56 GALLONS USABLE FUEL

CONDITIONS:  
2950 Pounds  
Recommended Lean Mixture for Cruise  
Standard Temperature

- NOTES:
1. This chart allows for the fuel used for engine start, taxi, takeoff and climb, and the time during a normal climb as shown in figure 5-6 (sheet 2).
  2. Reserve fuel is based on 45 minutes at 45% BHP and is 6.5 gallons.

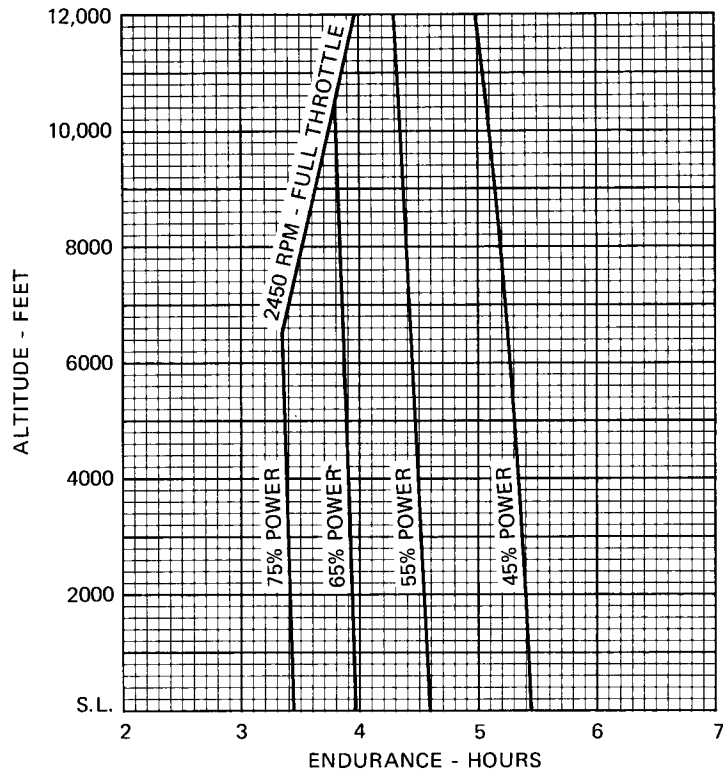

Figure 5-9. Endurance Profile (Sheet 1 of 2)

### ENDURANCE PROFILE 45 MINUTES RESERVE 75 GALLONS USABLE FUEL

CONDITIONS:  
2950 Pounds  
Recommended Lean Mixture for Cruise  
Standard Temperature

- NOTES:
1. This chart allows for the fuel used for engine start, taxi, takeoff and climb, and the time during a normal climb as shown in figure 5-6 (sheet 2).
  2. Reserve fuel is based on 45 minutes at 45% BHP and is 6.5 gallons.

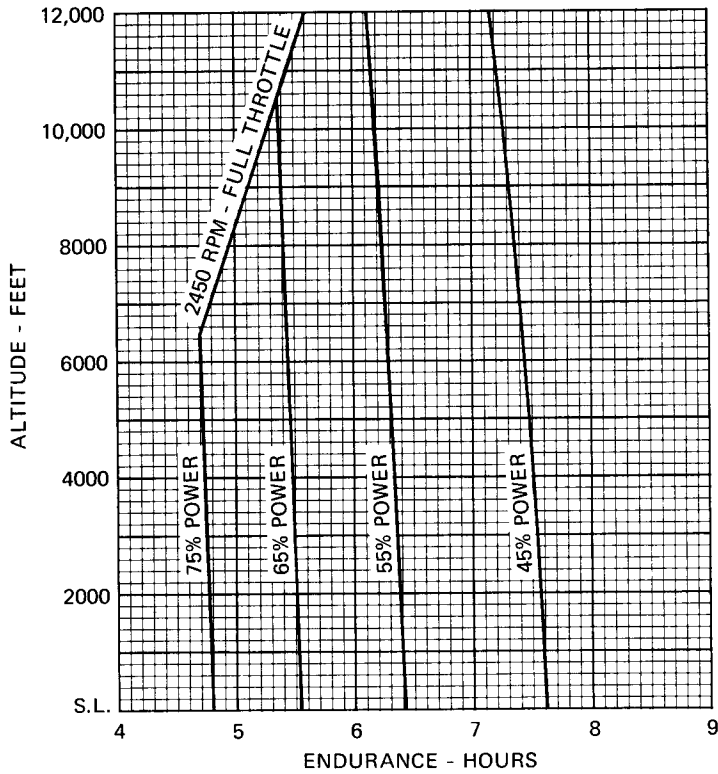

Figure 5-9. Endurance Profile (Sheet 2 of 2)

## LANDING DISTANCE

CONDITIONS:  
Flaps 40°  
Power Off  
Maximum Braking  
Paved, Level, Dry Runway  
Zero Wind

NOTES:

1. Maximum performance technique as specified in Section 4.
2. Decrease distances 10% for each 9 knots headwind. For operation with tailwinds up to 10 knots, increase distances by 10% for each 2 knots.
3. For operation on a dry, grass runway, increase distances by 40% of the "ground roll" figure.

WEIGHT LBS	SPEED AT 50 FT KIAS	PRESS ALT FT	0°C			10°C			20°C			30°C			40°C		
			GRND ROLL	TO CLEAR 50 FT OBS	TOTAL	GRND ROLL	TO CLEAR 50 FT OBS	TOTAL	GRND ROLL	TO CLEAR 50 FT OBS	TOTAL	GRND ROLL	TO CLEAR 50 FT OBS	TOTAL	GRND ROLL	TO CLEAR 50 FT OBS	TOTAL
2950	60	S.L.	560	1300	1335	580	1365	1365	600	1365	1365	620	1400	1400	640	1400	1435
		1000	580	1335	1365	600	1400	1400	620	1440	1440	645	1480	1480	665	1515	1475
		2000	600	1370	1405	625	1445	1445	645	1485	1485	670	1525	1525	695	1560	1560
		3000	625	1410	1445	645	1485	1485	670	1525	1525	695	1565	1565	715	1600	1600
		4000	650	1450	1485	670	1525	1525	720	1610	1610	745	1660	1660	770	1700	1700
		5000	670	1485	1525	695	1565	1565	745	1660	1660	775	1710	1710	800	1750	1750
		6000	700	1530	1575	725	1615	1615	780	1665	1665	805	1710	1710	830	1760	1760
		8000	725	1575	1625	750	1665	1665	810	1715	1715	835	1760	1760	865	1805	1805

Figure 5-10. Landing Distance



# SECTION 6 WEIGHT & BALANCE/ EQUIPMENT LIST

## TABLE OF CONTENTS

	Page
Introduction . . . . .	6-3
Airplane Weighing Procedures . . . . .	6-3
Weight and Balance . . . . .	6-5
Baggage and Cargo Tie-Down . . . . .	6-6
Equipment List . . . . .	6-15



## INTRODUCTION

This section describes the procedure for establishing the basic empty weight and moment of the airplane. Sample forms are provided for reference. Procedures for calculating the weight and moment for various operations are also provided. A comprehensive list of all Cessna equipment available for this airplane is included at the back of this section.

It should be noted that specific information regarding the weight, arm, moment and installed equipment list for this airplane can only be found in the appropriate weight and balance records carried in the airplane.

## AIRPLANE WEIGHING PROCEDURES

- (1) Preparation:
  - a. Inflate tires to recommended operating pressures.
  - b. Remove the fuel tank sump quick-drain fittings and fuel selector valve drain plug to drain all fuel.
  - c. Remove oil sump drain plug to drain all oil.
  - d. Move sliding seats to the most forward position.
  - e. Raise flaps to the fully retracted position.
  - f. Place all control surfaces in neutral position.
- (2) Leveling:
  - a. Place scales under each wheel (minimum scale capacity, 1000 pounds).
  - b. Deflate the nose tire and/or lower or raise the nose strut to properly center the bubble in the level (see Figure 6-1).
- (3) Weighing:
  - a. With the airplane level and brakes released, record the weight shown on each scale. Deduct the tare, if any, from each reading.
- (4) Measuring:
  - a. Obtain measurement A by measuring horizontally (along the airplane center line) from a line stretched between the main wheel centers to a plumb bob dropped from the firewall.
  - b. Obtain measurement B by measuring horizontally and parallel to the airplane center line, from center of nose wheel axle, left side, to a plumb bob dropped from the line between the main wheel centers. Repeat on right side and average the measurements.
- (5) Using weights from (3) and measurements from (4) the airplane weight and C. G. can be determined.

SECTION 6  
WEIGHT & BALANCE/  
EQUIPMENT LIST

CESSNA  
MODEL 182P

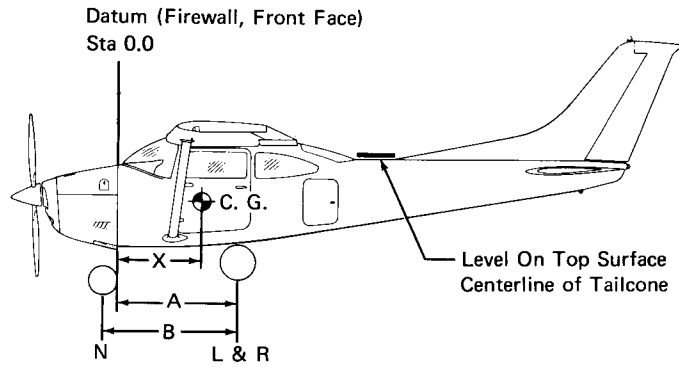

Scale Position	Scale Reading	Tare	Symbol	Net Weight
Left Wheel			L	
Right Wheel			R	
Nose Wheel			N	
Sum of Net Weights (As Weighed)				W

$$X = \text{ARM} = \frac{(A) - (N) \times (B)}{W}; X = ( \quad ) - \frac{( \quad ) \times ( \quad )}{( \quad )} = ( \quad ) \text{ IN.}$$

Item	Moment/1000	
	Weight (Lbs.)	X C.G. Arm (In.) = (Lbs.-In.)
Airplane Weight (From Item 5, page 6-3)		
Add Oil:		
No Oil Filter (12 Qts at 7.5 Lbs/Gal)		-15.0
With Oil Filter (13 Qts at 7.5 Lbs/Gal)		-15.0
Add Unusable Fuel:		
Std. Tanks (5 Gal at 6 Lbs/Gal)		46.0
L.R. Tanks (5 Gal at 6 Lbs/Gal)		46.0
Equipment Changes		
Airplane Basic Empty Weight		

Figure 6-1. Sample Airplane Weighing



- (6) Basic Empty Weight may be determined by completing Figure 6-1.

## WEIGHT AND BALANCE

The following information will enable you to operate your Cessna within the prescribed weight and center of gravity limitations. To figure weight and balance, use the Sample Problem, Loading Graph, and Center of Gravity Moment Envelope as follows:

Take the basic empty weight and moment from appropriate weight and balance records carried in your airplane, and enter them in the column titled YOUR AIRPLANE on the Sample Loading Problem.

### NOTE

In addition to the basic empty weight and moment noted on these records, the c. g. arm (fuselage station) is also shown, but need not be used on the Sample Loading Problem. The moment which is shown must be divided by 1000 and this value used as the moment/1000 on the loading problem.

Use the Loading Graph to determine the moment/1000 for each additional item to be carried; then list these on the loading problem.

### NOTE

Loading Graph information for the pilot, passengers, baggage/cargo and hatshelf is based on seats positioned for average occupants and baggage/cargo or hatshelf items loaded in the center of these areas as shown on the Loading Arrangements diagram. For loadings which may differ from these, the Sample Loading Problem lists fuselage stations for these items to indicate their forward and aft c. g. range limitation (seat travel and baggage/cargo or hatshelf area limitation). Additional moment calculations, based on the actual weight and c. g. arm (fuselage station) of the item being loaded, must be made if the position of the load is different from that shown on the Loading Graph.

Total the weights and moments/1000 and plot these values on the Center of Gravity Moment Envelope to determine whether the point falls within the envelope, and if the loading is acceptable.

## BAGGAGE AND CARGO TIE-DOWN

A nylon baggage net having six tie-down straps is provided as standard equipment to secure baggage in the area aft of the rear seat and on the hatshelf. Six eyebolts serve as attaching points for the net. Two eyebolts for the forward tie-down straps are mounted on the cabin floor near each sidewall just forward of the baggage door approximately at station 92; two center eyebolts mount on the floor slightly inboard of each sidewall just aft of the baggage door approximately at station 109; the two aft eyebolts secure at the top of the rear baggage wall at station 124. If a child's seat is installed, only the center and aft eyebolts will be needed for securing the net in the area remaining behind the seat. A placard on the baggage door defines the weight limitations in the baggage areas.

A cargo tie-down kit consisting of nine tie-down attachments is available if it is desired to remove the rear seat (and child's seat, if installed) and utilize the rear cabin area to haul cargo. Two tie-down attachments clamp to the aft end of the two outboard front seat rails and are locked in place by a bolt which must be tightened to a minimum of fifty inch pounds. Seven tie-down attachments bolt to standard attach points in the cabin floor, including three rear seat mounting points. The seven attach points are located as follows: two are located slightly inboard and just aft of the rear doorposts approximately at station 69; two utilize the aft outboard mounting points of the rear seat; one utilizes the rearmost mounting point of the aft center attach point for the rear seat approximately at station 84 (a second mounting point is located just forward of this point but is not used); and two are located just forward of the center baggage net tie-down eyebolts approximately at station 108. The maximum allowable cabin floor loading of the rear cabin area is 200 pounds/square foot; however, when items with small or sharp support areas are carried, the installation of a 1/4" plywood floor is recommended to protect the airplane structure. The maximum rated load weight capacity for each of the seven tie-downs is 140 pounds and for the two seat rail tie-downs is 100 pounds. Rope, strap, or cable used for tie-down should be rated at a minimum of ten times the load weight capacity of the tie-down fittings used. Weight and balance calculations for cargo in the area of the rear seat, baggage and hatshelf area can be figured on the Loading Graph using the lines labeled 2nd Row Passengers or Cargo and/or Baggage or Passengers on Child's Seat.

### SAMPLE WEIGHT AND BALANCE RECORD

(Continuous History of Changes in Structure or Equipment Affecting Weight and Balance)

AIRPLANE MODEL		SERIAL NUMBER			PAGE NUMBER				
		WEIGHT CHANGE			RUNNING BASIC EMPTY WEIGHT				
DATE	ITEM NO.		DESCRIPTION OF ARTICLE OR MODIFICATION	ADDED (+)		REMOVED (-)		Wt. (lb.)	Moment /1000
	In	Out		Arm (In.)	Moment /1000	Wt. (lb.)	Arm (In.)		

Figure 6-2. Sample Weight and Balance Record

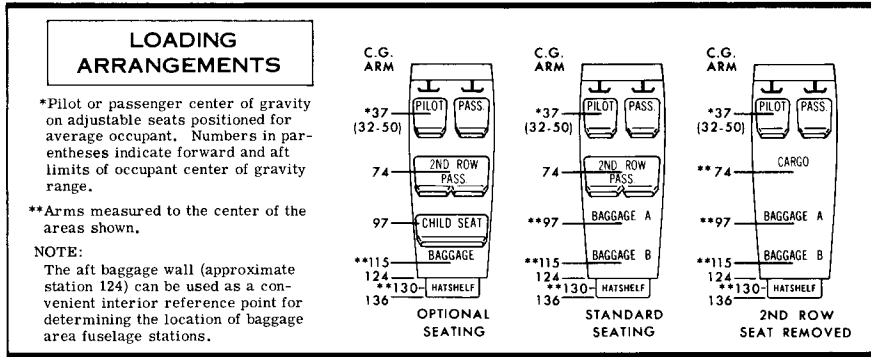
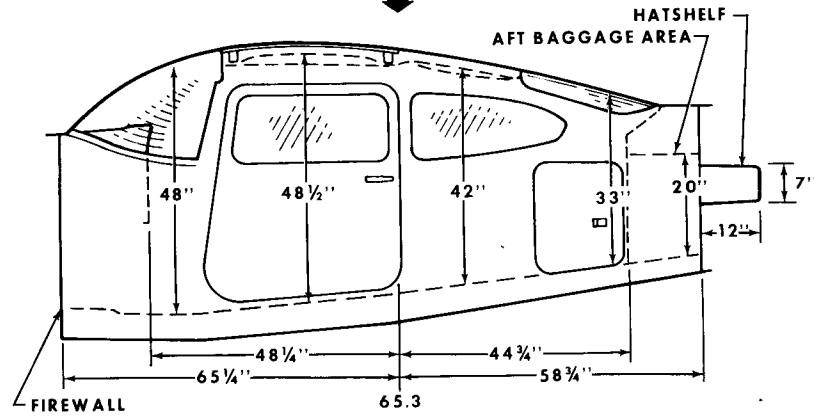

Figure 6-3. Loading Arrangements

**CABIN HEIGHT MEASUREMENTS**



**DOOR OPENING DIMENSIONS**

	WIDTH (TOP)	WIDTH (BOTTOM)	HEIGHT (FRONT)	HEIGHT (REAR)	
CABIN DOOR	32"	36 1/2"	41"	38 1/2"	== WIDTH ==
BAGGAGE DOOR	15 3/4"	15 3/4"	22"	20 1/2"	● LWR WINDOW LINE
					* CABIN FLOOR

**CABIN WIDTH MEASUREMENTS**

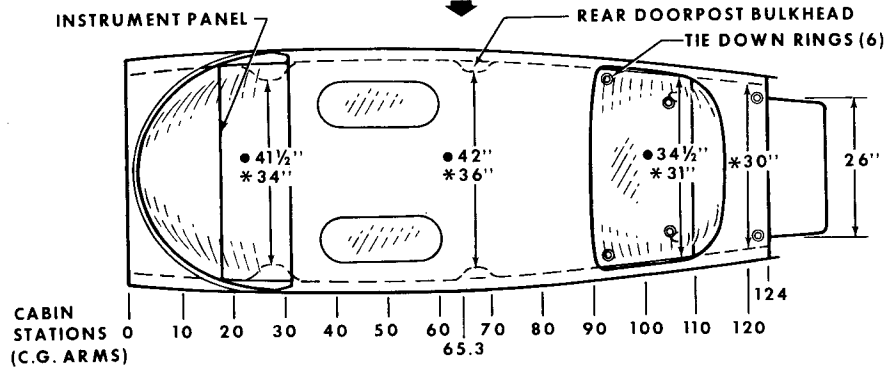
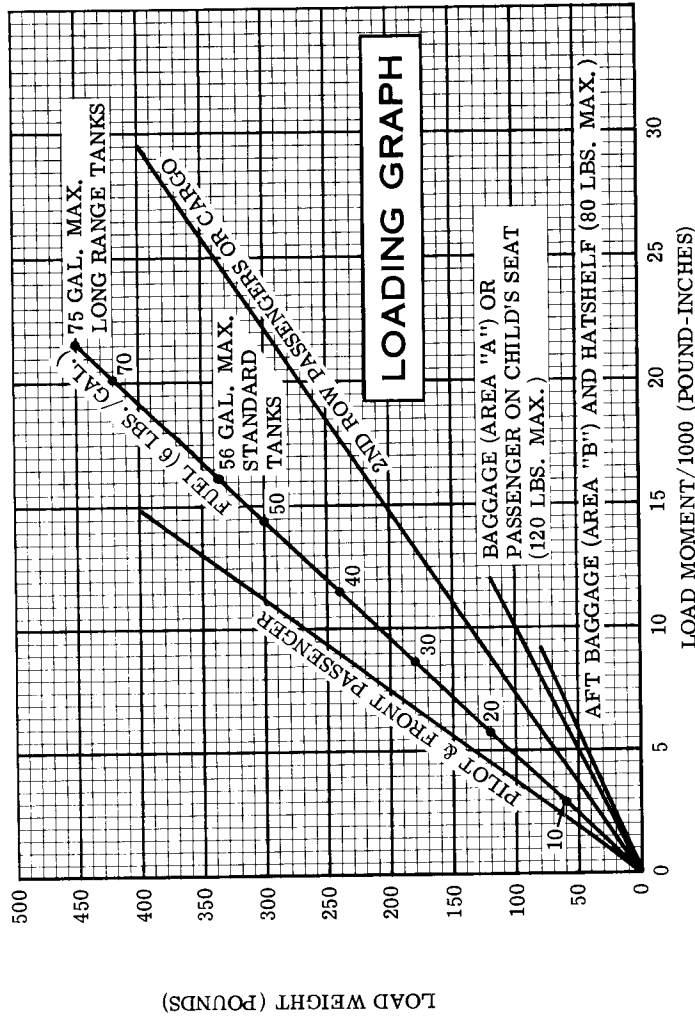

Figure 6-4. Internal Cabin Dimensions

SAMPLE AIRPLANE	YOUR AIRPLANE	
	Weight (lbs.)	Moment (lb.-ins./1000)
<p style="text-align: center;"><b>SAMPLE LOADING PROBLEM</b></p> <p>1. Basic Empty Weight (Use the data pertaining to your airplane as it is presently equipped. Includes unusable fuel and full oil) . . . . .</p> <p>2. Usable Fuel (At 6 Lbs./Gal.) Standard Tanks (56 Gal. Maximum) . . . . . Long Range Tanks (75 Gal. Maximum) . . . . .</p> <p>3. Pilot and Front Passenger (Sta. 32 to 50) . . . . .</p> <p>4. Second Row Passengers . . . . . Cargo Replacing Second Row Seats (Station 65 to 82) . . . . .</p> <p>5. Baggage (Area "A") or Passenger on Child's Seat (Station 82 to 108) 120 Lbs. Maximum . . . . .</p> <p>6. Baggage - Aft (Area "B") and Hatshelf (Station 108 to 136) 80 Lbs. Maximum . . . . .</p> <p>7. TOTAL WEIGHT AND MOMENT</p> <p>8. Locate this point (2950 at 133.6) on the Center of Gravity Moment Envelope, and since this point falls within the envelope, the loading is acceptable.</p>	1772	63.3
	336	16.1
	340	12.6
	340	25.2
	120	11.6
	42	4.8
	2950	133.6

Figure 6-5. Sample Loading Problem



NOTES: (1) Line representing adjustable seats shows pilot and front passenger center of gravity on adjustable seats positioned for an average occupant. Refer to the Loading Arrangements diagram for forward and aft limits of occupant c. g. range.  
(2) Hatshelf Maximum Load 25 Lbs.

Figure 6-6. Loading Graph

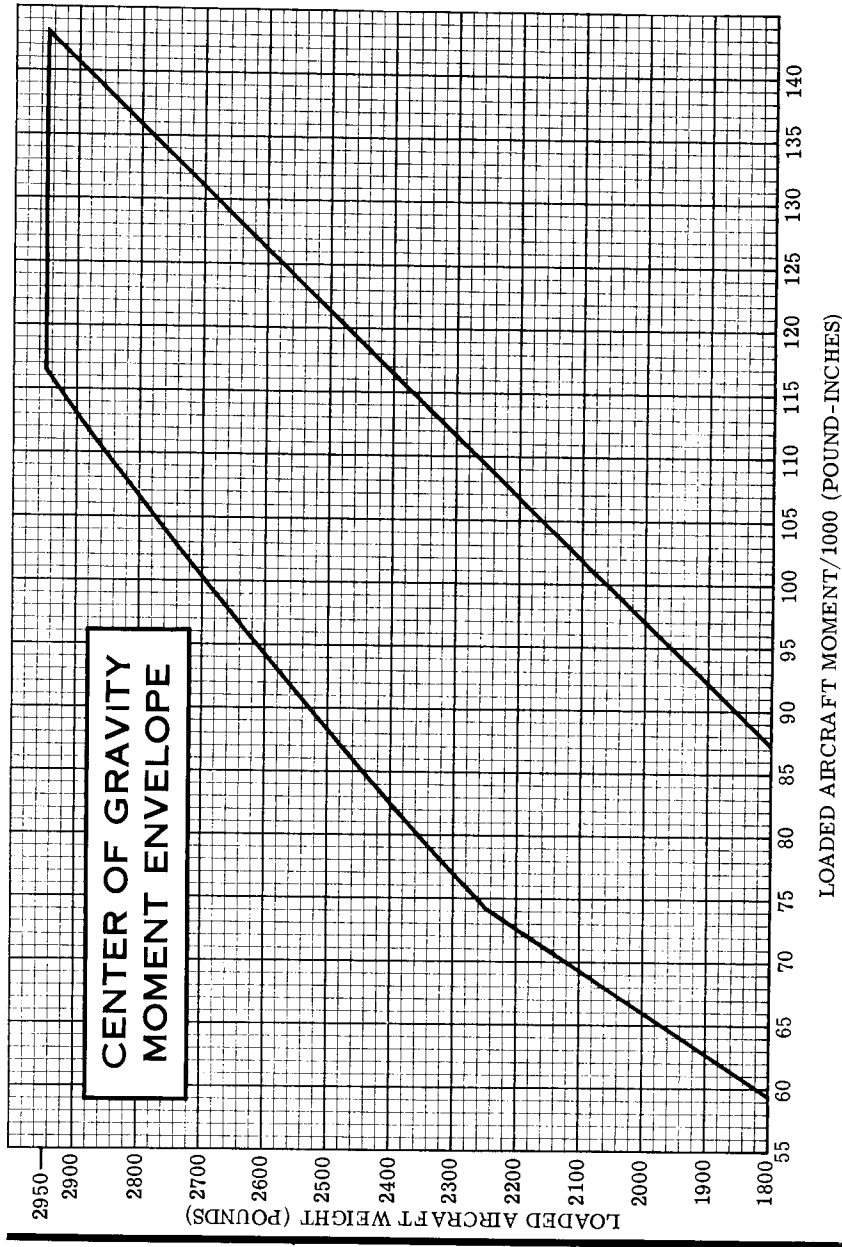

Figure 6-7. Center of Gravity Moment Envelope



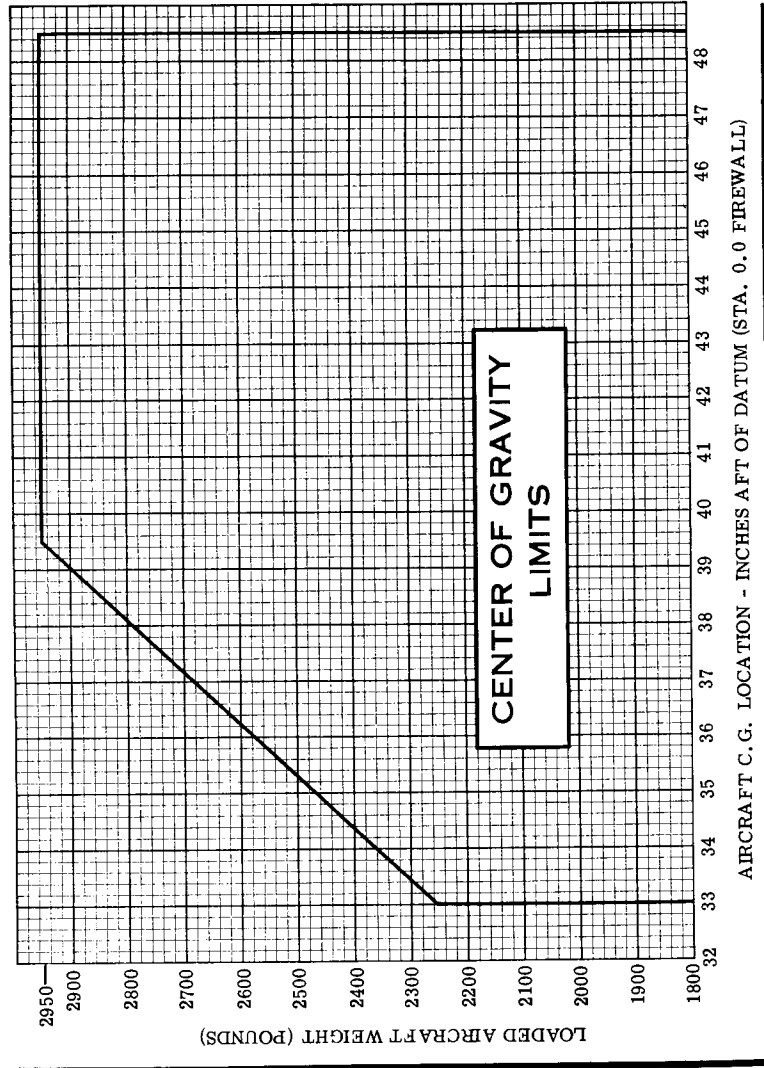

Figure 6-8. Center of Gravity Limits



## EQUIPMENT LIST

The following equipment list is a comprehensive list of all Cessna equipment available for this airplane. A separate equipment list of items installed in your specific airplane is provided in your aircraft file. The following list and the specific list for your airplane have a similar order of listing.

This equipment list provides the following information:

An item number gives the identification number for the item. Each number is prefixed with a letter which identifies the descriptive grouping (example: A. Powerplant & Accessories) under which it is listed. Suffix letters identify the equipment as a required item, a standard item or an optional item. Suffix letters are as follows:

- R = required items of equipment for FAA certification
- S = standard equipment items
- O = optional equipment items replacing required or standard items
- A = optional equipment items which are in addition to required or standard items

A reference drawing column provides the drawing number for the item.

### NOTE

If additional equipment is to be installed, it must be done in accordance with the reference drawing, accessory kit instructions, or a separate FAA approval.

Columns showing weight (in pounds) and arm (in inches) provide the weight and center of gravity location for the equipment.

### NOTE

Unless otherwise indicated, true values (not net change values) for the weight and arm are shown. Positive arms are distances aft of the airplane datum; negative arms are distances forward of the datum.

### NOTE

Asterisks (\*) after the item weight and arm indicate complete assembly installations. Some major components of the assembly are listed on the lines immediately following. The summation of these major components does not necessarily equal the complete assembly installation.

ITEM NO	EQUIPMENT LIST DESCRIPTION	REF DRAWING	WT LBS	ARM INS
A01-R	ENGINE, CONTINENTAL O-470-S SPEC. 1 TWO MAGNETOS WITH IMPULSE COUPLING OIL COOLER-HARRISON TWELVER, 18MM X 3/4 20-3A SPARK PLUGS STARTER, CARBURETOR AIR FILTER, CARBURETOR AIR ALTERNATOR, 14 VOLT, 60 AMP OIL COOLER, NON-COOLING ON ITEM A01-R AND REPLACES OIL COOLER DESIGNATION TO O-470-S SPECIFICATION 2 (NET CHANGE) OIL COOLER, CONTINENTAL O-470-S	0750201 SLICK 662 TCM 527392 SH 200A TCM 634592 0750038-4 C611501-0102 TCM639171	442.0* 12.9 7.6 17.8 11.0 11.5	-17.5* -12.0 -31.5 -19.0 -4.0 -33.0 -5.5 -31.5
A05-R	REPLACES ENGINE DESIGNATION TO O-470-S SPECIFICATION 2 (NET CHANGE) ENGINE OIL	0750606-11	4.5*	-3.4*
A17-C	FILTER INSTALLATION, FULL FLOW ENGINE OIL ADAPTOR ASSEMBLY FILTER CAN ASSEMBLY (AC 6436992) FILTER ELEMENT KIT	1250322-3 C294505-0101 C294505-0102 C161009-0104 C161031-0101 0752637-11	1.5 1.8 0.3 51.4 3.0 3.0 1.7 1.2 1.5*	-4.2 -3.0 -3.0 -41.5* -42.0* -44.5 -46.5 -37.0* -37.0*
A21-A	PROPELLER, PROPELLER 2A34C203/90DCA-8 SPINNER, PROPELLER (MCCAULEY C290-D3/T1) SPINNER INSTALLATION, PROPELLER SPINNER DCME FORWARD SPINNER SUPPORT AFT SPINNER BULKHEAD VACUUM SYSTEM, ENGINE DRIVEN VACUUM PUMP (AV. OF 4) SUCTON GAGE PRIMING SYSTEM, SIX CYLINDER OIL QUICK DRAIN VALVE (NET CHANGE)	0752637-11 1752637-1 0706003-1 C668540-0101 0750125-1 1701015-4	2.8 2.0 1.0 NEGL	-3.7 -16.7 -
A33-R	SPINNER, DCME	C668540-0101	1.5*	-3.7
A37-R	PROPELLER, MCCAULEY 2A34C203/90DCA-8	C668540-0101	1.5*	-3.7
A41-R	SPINNER, PROPELLER (MCCAULEY C290-D3/T1)	0752637-11	3.0	-42.0*
A61-S	SPINNER, DCME	0752637-11	1.7	-44.5
A70-A	FORWARD SPINNER SUPPORT	0752637-11	1.2	-37.0*
A73-A	AFT SPINNER BULKHEAD	0752637-11	1.5*	-37.0*
B01-R-1	VACUUM SYSTEM, ENGINE DRIVEN VACUUM PUMP (AV. OF 4) SUCTON GAGE PRIMING SYSTEM, SIX CYLINDER OIL QUICK DRAIN VALVE (NET CHANGE)	C668540-0101 0750125-1 1701015-4	2.8 2.0 1.0 NEGL	-3.7 -16.7 -
	A. POWERPLANT & ACCESSORIES			
	B. LANDING GEAR & ACCESSORIES			
	WHEEL, BRAKE & TIRE ASSY, 6.00X6 MAIN (2) WHEEL ASSY, CLEVELAND 40-113 (EACH) BRAKE ASSY, CLEVELAND 30-75 (LEFT) BRAKE ASSY, CLEVELAND 30-75 (RIGHT) TIRE, 6-PLY RATED BLACKWALL (EACH)	1241156-138 C163001-0104 C163030-0113 C163030-0114 C2622003-0204	39.8* 7.4 1.9 8.4	58.6* 58.9 55.5 58.9

ITEM NO	EQUIPMENT LIST DESCRIPTION	REF DRAWING	WT LBS	ARM INS
B01-R-2	TIRE, BRAKE & TIRE ASSY, 6.00X6 (EACH) WHEEL ASSEMBLY, MAIN (2) BRAKE ASSY, MCCAULEY C-30018 (EACH) BRAKE ASSY, MCCAULEY C-30018 (LEFT) BRAKE ASSY, MCCAULEY C-30018 (RIGHT) TIRE, 6-PLY RATED BLACKWALL (EACH) TUBE	C262023-0102 C163003-0207 C163003-0102 C163003-0109 C163003-0108 C262003-0204 C262023-0102 1241156-12 1241156-12 C262003-0202 C262023-0101 C163003-0101 C163003-0101 C163003-0401 C262003-0202 C262023-0101	1.9 39.0* 1.8 1.8 1.9 1.9* 2.8 2.0 1.9* 1.9* 3.0 3.0 1.2 18.9 3.7 50.6 2.6 4.5	58.9 58.9 55.5 55.5 58.9 58.9* 7.1 7.1 7.1 7.1 7.1 7.1 7.1 45.9* 60.2 58.9 58.9
B04-R-1	TIRE, 5.00X5 NOSE WHEEL ASSEMBLY, GLEVELAND 40-77 TIRE, 6-PLY RATED BLACKWALL	1241156-12 C262003-0202 C262023-0101	1.9 2.8 2.0	7.1 7.1 7.1
B04-R-2	TIRE, 5.00X5 NOSE WHEEL ASSEMBLY, MCCAULEY C-30053 TIRE, 6-PLY RATED BLACKWALL	C163003-0101 C163003-0401 C262003-0202 C262023-0101	1.9 3.0 3.0 1.2	7.1 7.1 7.1 45.9*
B10-S	FAIRING INSTALLATION, WHEEL (SET OF 3) NOSE WHEEL FAIRING (EACH) MAIN WHEEL FAIRING (EACH) BRAKE DISC FAIRING (EACH) AXLE, STANDARD DUTY MAIN GEAR (SET OF 2) AXLE, HEAVY DUTY MAIN GEAR (SET OF 2)	0741638 05443079 0541223 0741641 0541124-1 1441003-01	18.9 3.7 50.6 2.6 4.5	45.9* 60.2 58.9 58.9
B16-R				
B16-O				
C. ELECTRICAL SYSTEM				
C01-R	BATTERY, 12 VOLT, 33 AMP HR	0712605-1	26.5	130.5
C04-R	REGULATOR, 14 VOLT, 60 AMP ALTERNATOR	C611001-0201	0.2	0.7
C07-A	GROUND SERVICE PLUG RECEPTACLE	0701019-1	3.8*	217.7*
C10-A	ELECTRIC ELEVATOR TRIM INSTL	0760134-1	3.3	221.0
C19-C	ELECTRIC DRIVE ASSEMBLY HEATING SYSTEM, PITOT & STALL WARNING	077024-1	0.5	26.5
C22-A	SWITCH, INSTRUMENT POST	0713333-5	0.5	17.5
C23-A	MAG LIGHT CONTROL WHEEL MOUNTED	0760020-19	0.5	17.0
C31-A	MAG LIGHT COURTESY (NET CHANGE)	0700615-9	NEGL*	61.7
C40-A	DETECTORS, NAVIGATION LIGHT (SET OF 2)	0701013	1.7	208.6
C43-A	DMN I FLASHING BEACON LIGHT LIGHT ASSY (IN FIN TIP) FLASHER ASSY (IN FIN TIP) LOADING RESISTOR	C621001-0106 C594502-0101 0R95-1.5	0.7 0.4 0.2	253.0 253.0 212.0

SECTION 6  
WEIGHT & BALANCE/  
EQUIPMENT LIST

CESSNA  
MODEL 182P

ITEM NO	EQUIPMENT LIST DESCRIPTION	REF DRAWING	WT LBS	ARM INS
C46-A	STROBE LIGHTS, WHITE (EACH WING TIP)	0701018-1	2.6*	44.4*
	POWER SUPPLY (AERO-FLASH 73-140)(2)	C222007-0101	2.3	46.7
	LIGHT ASSY. (AERO-FLASH 73-145)(2)	C222006-0101	0.3	42.0*
C49-S	LIGHT INSTL. COWL MOUNTED LANDING & TAXI LIGHT BULBS (SET OF 2)	0770771 GE-4509	1.6*	-32.5
	D. INSTRUMENTS			
D01-R	INDICATOR, AIRSPEED	C661064-0204	0.6	16.0
D01-O	INDICATOR, TRUE AIRSPEED (NET CHANGE)	1201008-7	0.2	16.5
D04-A	STATIC ALTITUDE AIR SOURCE	0701028-1	0.3	14.4
D07-R	ALTIMETER, SENSITIVE	C661071-0101	1.0	15.3
D07-C-1	ALTIMETER, SENSITIVE (FEET & MILLIBARS)	C661071-0102	1.0	15.3
D07-C-2	ALTIMETER, SENSITIVE (20 FT. MARKINGS)	C661025-0102	1.0	15.3
D10-A	ALTIMETER, INSTALLATION (2ND UNIT)	1213681-1	1.0	16.0
D16-A-1	ENCODING ALTIMETER (REQUIRES RELOCATING STANDARD ALTIMETER)	1213732	3.0	14.0
D16-A-2	ENCODING ALTIMETER, FEET AND MILLIBARS (REQUIRES RELOCATING STANDARD TYPE ALTIMETER)	1213732	3.0	14.0
D22-A	GAGE, BAROMETRIC AIR TEMPERATURE	0750610-1	1.0	5.5
D25-S	CLOCK, ELECTRIC (0770771)	C664508-0101	0.4	16.5
D28-R	COMPASS, MAGNETIC & MCUNT	1213679-2	1.1	16.5
D34-R	INSTRUMENT CLUSTER, ENGINE & FUEL	C669502-0202	1.3	16.5*
D49-A	INDICATOR INSTALLATION, ECONOMY MIXTURE EGT INDICATOR	0750609-2	0.4*	18.2*
	THERMOCOUPLE PROBE	C668501-0211	0.1	17.5
D64-S	GYRO SYSTEM INSTL (NON AUTO-PILOT)	C668501-0204	0.1	-20.5*
	ATTITUDE INDICATOR (AV. OF 4)	0701030-1	5.9*	13.3*
	ATTITUDE INDICATOR (AV. OF 3)		2.7	14.1
	HOSES, FITTINGS, SCREWS, CLAMPS ETC. AUTOPILOT		2.2	14.4
D64-O	GYRO SYSTEM INSTL. FOR NAV-D-MATIC 300A	0701038-1	1.7*	11.0*
	DIRECTIONAL INDICATOR (AV. OF 2)	40760	3.2	13.0
	ATTITUDE INDICATOR (AV. OF 3)	1201126	3.2	14.4
D64-O-2	DIRECTIONAL INDICATOR WITH MOVABLE HEADING INDEX PRINTER, NON AUTOPILOT (USED WITH D64-S AND REPLACES STD DIRECTIONAL		3.1	14.1

ITEM NO	EQUIPMENT LIST DESCRIPTION	REF DRAWING	WT LBS	ARM INS
D67-A	INDICATOR, HOURMETER, INSTALLATION RECORDING INDICATOR	1200744	0.8*	11.8*
D73-R	OIL PRESSURE SWITCH	C664501-0103	0.5	17.5
D82-S	GAGE, MANIFOLD PRESSURE	S1711-2	0.2	1.1
D85-R	GAGE, OUTSIDE AIR TEMPERATURE	C662035-0101	0.9	15.85
D88-S	TACHOMETER INSTALLATION, ENGINE	C668007-0101	0.1*	28.5*
D88-0-1	RECORDING INSTAL INDICATOR	U706006	0.7	13.9
D88-0-2	TACH FLEXIBLE SHAFT (ASES 1605-24)	C6680020-0104	0.2	13.0
D91-S	INDICATOR, TURN COORDINATOR (FOR N.O.M.*S)	S-1605-2	1.3	16.0
	INDICATOR, TURN COORDINATOR (FOR N.O.M.*S)	C661003-0504	1.9	15.25
	INDICATOR, TURN & BANK	42320-0014	2.0	15.5
	INDICATOR, RATE OF CLIMB	S-1413-2	1.0	15.4
		C661080-0101		
	E. CABIN ACCOMMODATIONS			
E05-R	SEAT, ADJUSTABLE FORE & AFT - PILOT	0714019-10	13.0	44.9
E05-O	SEAT, ARTICULATING VERT. ADJ. - PILOT	0714020-13	24.0	41.0
E07-S	SEAT, ADJUSTABLE FORE & AFT - CO-PILOT	0714019-10	13.0	44.0
E07-O	SEAT, ARTICULATING VERT. ADJ. - CO-PILOT	0714020-13	24.0	41.5
E09-S	SEAT, 2ND ROW BENCH	0714021-17	23.0	80.5
E11-A	SEAT, INSTALLATION, AUXILIARY (CHILDS)	0501009-5	8.2*	104.2*
E15-R	SEAT ASSY, LAP	0714022-4	6.9	104.4
E15-S	BELT ASSY, LAP (PILOT SEAT)	S1746-5	0.9	101.1
E15-O	SHOULDER HARNESS ASSY, PILOT	S2275-103	1.0	37.0
E19-O	BELT & SHOULDER HARNESS ASSY, PILOT (FOR AUSTRALIA)	S2275-201	0.6	37.0
E23-O	PILOT & CO-PILOT INERTIA REEL INSTL. (NET CHANGE)	S2275-3VH	1.6	92.0
E23-S	BELT & SHOULDER HARNESS ASSY, CO-PILOT	0701077	3.6	37.0
E27-S	BELT & SHOULDER HARNESS ASSY, CO-PILOT (FOR AUSTRALIA)	S2275-3	1.6	37.0
E27-O-1	BELT ASSY, 2ND ROW OCCUPANTS (SET OF 2)	S-1746-1	1.6	74.5
E27-O-2	BELT & SHOULDER HARNESS ASSY, 2ND ROW (FOR AUSTRALIA)	S2275-7	3.2	74.0
E35-A-1	INTERIOR, VINYL SEAT COVERS (NET CHANGE)	S2275-7VH	3.2	74.0
E35-A-2	INTERIOR, LEATHER SEAT COVERS (NET CHANGE)	CES-1154	0.0	-
		CES-1154	2.0	62.3

SECTION 6  
WEIGHT & BALANCE/  
EQUIPMENT LIST

CESSNA  
MODEL 182P

ITEM NO	EQUIPMENT LIST DESCRIPTION	REF DRAWING	WT LBS	ARM INS
E37-0	OPENABLE RH CABIN DOOR WINDOW (NET CHANGE)	0701065-1	2.3	47.0
E39-A	WINDOWS, OVERHEAD CABIN TOP (NET CHANGE)	0701017-1	0.6	45.3
E43-A	VENTILATION SYSTEM, 2ND ROW SEATING	0701084-1	3.6	62.3
E45-S	CURTAIN, REAR WINDOW	0700707-12	1.5	112.0*
E47-A	OXYGEN SYSTEM, 4 PORT	0701091-1	34.0*	128.3
	OXYGEN CYLINDER, EMPTY	C166001-0601	2	128.3
E49-A	OXYGEN - 48 CU FT @ 1800 PSI		4.0	16.0
E50-A	CUP HOLDER, RETRACTABLE (SET OF 2)	1201124	0.1	16.0
E51-A	HEADREST, 1ST ROW (INSTALLED ARM) (EACH)	1215073-1	0.9	47.0
E53-A	MIRROR, 2ND ROW (INSTALLED ARM) (EACH)	1215073-1	0.9	87.0
E55-S	MIRROR, REAR VIEW (SET OF 2)	1201041	0.3	16.0
E59-S	SUN VISORS (SET OF 2)	0701024-1	1.0	33.0
E61-A	APPROACH PLATE HOLDER	0715046-1	0.1	27.5
E61-A	SHELF, REMOVABLE UTILITY (INSTALLED ARM)	0711682-3	1.0	105.5
E65-S	BAGGAGE TIE DOWN NET	1215042-1	0.5	108.0
E71-A	CARGO TIE DOWN LATCHES & SEAT RAIL CLAMPS (USE INSTALLED CARGO ARMS) (STOWED)	0701029-1	1.2	
E75-A	STRETCHER, INSTALLED, DUAL (CUSTOM AIR)			
E85-A	(USE ACTUAL INSTALLATION WEIGHT AND ARM)	0700164-3	-	-
E85-A	CONTROLS, INSTALLATION, DUAL (CO-PILOT)			
E89-A	WHEEL, PEDALS & TIE BRAKES	0760101-2	8.7	16.1
E93-R	CONTROL WHEEL, PILOT ALL PURPOSE (NET CHG)	0760650-3	NEGL	-
	HEATING SYSTEM, CABIN & CARGO	0760020-21	18.0	-16.0
	(INCLUDES EXHAUST SYSTEM)	0750201		
	F. PLACARDS & WARNING			
F01-R	PLACARD, OPERATIONAL LIMITATIONS-VFR DAY	0705055	NEGL	-
F01-O-1	PLACARD, OPERATIONAL LIMITATIONS-VFR DAY-NIGHT	0705055	NEGL	-
F01-O-2	PLACARD, OPERATIONAL LIMITATIONS-IFR DAY-NIGHT	0705055	NEGL	-
F04-R	INDICATOR, STALL WARNING HORN-AUDIBLE	S-2077-5	1.0	17.5



ITEM NO	EQUIPMENT LIST DESCRIPTION	REF DRAWING	WT LBS	ARM INS
	G. AUXILIARY EQUIPMENT			
G01-A	TAILCONE LIFT HANDLES (SET OF 2)	0712033-1	1.0	186.5
G04-A	TOW HOOK, INSTALLED ARM SHOWN	0712642-1	0.5	231.0
G07-A	HOISTING RINGS, AIRPLANE	0700612-1	1.0	45.0
G13-A	CORROSION PROOFING, INTERNAL	0760007-1	7.0	70.0
G16-A	STATIC DISCHARGERS, (SET OF 10)	1201131-2	0.4	130.5
G19-A	STABILIZER ABRASION BOOTS	1200032-3	2.7	206.0
G22-S	TOWBAR, AIRCRAFT (STOWED ARM SHOWN)	0501019-1	1.6	97.0
G25-S	PAINT, OVERALL COVER-EXTERIOR	0704032	11.2*	93.2*
	OVERALL WHITE BASE (102773 SQ IN)		11.2	92.2
	COLOR STRIPE		0.5	116.0
G31-A	CABLES, CORROSION RESISTANT (NET CHANGE)	0760007-1	0.0	-
G55-A-1	FIRE EXTINGUISHER, HAND TYPE (FOR USE WITH STANDARD PILOT SEAT)	0701014-1	3.0	35.0
G55-A-2	FIRE EXTINGUISHER, HAND TYPE (FOR USE WITH VERTICAL ADJUSTING PILOT SEAT)	0701014-3	3.0	29.0
G89-A	WINTERIZATION KIT, ENGINE	0752647-2	1.1*	-29.9*
G92-A	WINTERIZATION KIT, INSTALLED ARM SHOWN	0720700	0.5	-34.3
	WINGS, EXTENDED RANGE FUEL (NET CHANGE)		7.0	56.5
	H. AVIONICS & AUTOPILOTS			
H01-A-1	CESSNA 300 ADF WITH BFO RECEIVER WITH BFO (R-546E) GONIOMETER INDICATOR (IN-346A) ADF LOOP ANTENNA & ASSOC. WIRING ADF SENSE ANTENNA MOUNTING BOX & MISC ITEMS	3910159-1 41240-0101 40980-1001 3910154	7.3* 2.3 2.09 2.1 0.3 1.7 8.4*	23.6* 13.0 16.0 33.4 96.2 17.0 21.6*
H01-A-2	CESSNA 400 ADF (W/BFO) ADF RECEIVER WITH BFO (R-446A) GONIOMETER INDICATOR (IN-346A) ADF LOOP ANTENNA & ASSOC. WIRING ADF SENSE ANTENNA MOUNTING BOX & MISC ITEMS	3910160-1 43090-1114 40980-1001 3910154	3.4 3.09 2.1 0.3 1.7 8.4*	11.5 16.0 33.4 96.2 17.0 21.6*
H04-A	DME INSTALLATION, NARCO	3910166-6	2.03 1.7 6.0*	98.2 17.0 14.4*

SECTION 6  
WEIGHT & BALANCE/  
EQUIPMENT LIST

CESSNA  
MODEL 182P

ITEM NO	EQUIPMENT LIST DESCRIPTION	REF DRAWING	WT LBS	ARM INS
H07-A	RECEIVER (OME 190) MOUNTING BOX	3312-400	4.9	11.0
H10-A	ANTENNA GLIDESLOPE	UDA-3	0.6	11.0
	CESSNA 400 (R-443R) RECEIVER (MOUNTED ON UPPER WINDSHIELD)	3910119	0.2*	88.4*
H11-A-1	ANTENNA HF TRANSCIVER 1ST UNIT	1270098-1	0.2*	130.6*
	PANTRONICS HF TRANSCIVER & MOUNT	3910156-3	27.3*	77.3*
	PT-10-A TRANSCIVER POWER SUPPLY	C582103-0101	3.8	110.1
	DX-10RL-14 REMOTE ANTENNA LOAD BOX	C589502-0201	4.2	112.0
	ANTENNA INSTALLATION 351 INCH LONG	0770750-916	4.3	114.1
	MICROPHONE INSTALLATION - HAND HELD	0770750-701	0.3	119.3
	HEADSET INSTALLATION	0770750-704	0.2	145.1
	CABIN SPEAKER INSTALLATION	0770750-741	0.2	145.1
	ENGINE NOISE FILTER	3940148	1.0	152.0
	RADIO CONTROL SYSTEM	3930152-5	1.0	152.0
	AUDIO CONTROL SYSTEM	3970120	1.9	130.0*
	PANTRONICS HF TRANSCIVER 2ND UNIT	3910156-4	19.8*	98.7*
	PT-10-A TRANSCIVER (HIGH FREQUENCY)	C582103-0101	3.8	111.1
DX-10RL-14 REMOTE POWER SUPPLY	C585103-0201	8.6	130.1	
ANTENNA 14 REMOTE ANTENNA LOAD BOX	C589502-0101	4.2	111.0	
H11-A-2	ANTENNA INSTL 351 INCHES LONG	0770750-616	23.2*	152.1*
	SUNAIR SSB HF TRANSCIVER 2ND UNIT	3910109-3	5.3	196.1*
H13-A	RE-1000 SINGLE BAND XCVR (ASB-125)	99688	5.2	138.0
	PA1010A REMOTE POWER AMPLIFIER	99682	8.5	137.0
	CU-110 ANTENNA COUPLER (LOAD BOX)	99680	0.3	152.1*
H16-A-1	ANTENNA INSTL 351 INCHES LONG	0770750-616	23.2*	152.1*
	CESSNA 400 MARKER BEACON	3910142-5	0.7	152.1*
H16-A-2	RECEIVER (R-402B)	424905114	2.0	164.4*
	ANTENNA, FLUSH MOUNTED IN TAILCONE	1270720-1	1.0	132.4*
H19-A	CESSNA 300 TRANSPONDER	3910127-6	3.6*	127.5*
	RECEIVER-TRANSMITTER (RT-359A)	41420-1114	2.7	127.5*
H19-A	ANTENNA (A-109A)	41530-0001	0.1	167.0*
	RECEIVER-TRANSMITTER (RT-459A)	3910128-2	3.6*	127.1*
H19-A	ANTENNA (A-109A)	41470-1114	2.8	127.1*
	ANTENNA 300 VHF TRANSCIVER 360 CHNL COM	41530-0001	0.1	167.0*
H19-A	1ST UNIT INSTALLATION	3910155	13.4*	167.0*
	VHF TRANSCIVER (RT-524A) (VOICE ONLY)	31390-1114	5.7	11.0
H19-A	ANTENNA & CABLE, LH VHF COM	0770750-701	0.8	47.4
	MICROPHONE INSTALLATION - HAND HELD		0.3	19.4

ITEM NO	EQUIPMENT LIST DESCRIPTION	REF DRAWING	WT LBS	ARM INS
H20-A	HEADSET INSTALLATION CABIN SPEAKER INSTALLATION ENGINE COOLING FILTER AUDIO CONTROL PANEL CESSNA 300 VHF TRANSMITTER 360 CHNL COM 2ND UNIT INSTALLATION RT-524A VHF TRANSMITTER (VOICE ONLY) ANTENNA & CABLE, RH VHF COM CESSNA 300 NAV/COM 360 CHANNEL COM VOR/LOC 1ST UNIT INSTALLATION (RT-308C) RECEIVER-TRANSMITTER (IN-5148) VOR/LOC INDICATOR (IN-5148) NOTE-- 1ST UNIT INSTL COMPONENTS ARE AS LISTED	0770750-704 0770750-741 3930152-5 3940148 3970120 3910155 31390-1114 3910151-5 42450-1114 45010-1000	0.2 1.0 1.0 0.1 1.9 8.2*	14.3 45.1 12.5 -6.0 13.0 14.8*
H22-A-1	ANTENNA & CABLE, LH VHF COM ANTENNA & CABLE, VOR/LOC NAV MICROPHONE INSTALLATION HAND HELD HEADSET INSTALLATION SPEAKER INSTALLATION RADIO COOLING FILTER ENGINE NOISE FILTER AUDIO CONTROL SYSTEM MOUNTING BOX, WIRING & ASSOC HARDWARE CESSNA 300 NAV/COM 720 CHANNEL COM VOR/LOC 1ST UNIT INSTALLATION (RT-328T) RECEIVER-TRANSMITTER (IN-5148) VOR/LOC INDICATOR (IN-5148) INSTL COMPONENTS SAME AS H22-A-1	0770750-701 0770750-704 0770750-741 3930152-5 3940148 3970120 3910150-9 43340-1124 45010-1000	0.8 1.5 1.0 0.2 1.0 0.1 1.6 16.8*	47.4 176.9 19.4 14.3 45.1 12.5 -6.0 13.0 10.8 32.0*
H22-A-2	CESSNA 300 NAV/COM 720 CHANNEL COM VOR/ILS 1ST UNIT INSTALLATION (RT-328T) RECEIVER-TRANSMITTER (IN-5258) VOR/ILS INDICATOR (IN-5258) INSTL COMPONENTS SAME AS H22-A-1	3910152-11 43340-1124 45010-1000	16.9*	31.9*
H22-A-3	CESSNA 300 NAV/COM 360 CHANNEL COM VOR/LOC 1ST UNIT INSTALLATION (RT-328T) RECEIVER-TRANSMITTER (IN-5258) VOR/ILS INDICATOR (IN-5258) INSTL COMPONENTS SAME AS H22-A-1	43340-1124 45010-2000	6.9 0.6	11.0 16.3
H22-A-4	CESSNA 300 NAV/COM 360 CHANNEL COM VOR/LOC 1ST UNIT INSTL (FOR EXPORT USE) RECEIVER-TRANSMITTER (RT-528E-1) VOR/LOC INDICATOR (IN-5148) INSTL COMPONENTS SAME AS H22-A-1	3910150-11 42430-1124 45010-1000	16.9*	31.9*
H22-A-5	CESSNA 300 NAV/COM 360 CHANNEL COM VOR/ILS 1ST UNIT INSTL (FOR EXPORT USE)	3910152	7.0 0.6 17.0*	11.0 16.3 31.8*

SECTION 6  
WEIGHT & BALANCE/  
EQUIPMENT LIST

CESSNA  
MODEL 182P

ITEM NO	EQUIPMENT LIST DESCRIPTION	REF DRAWING	WT LBS	ARM INS
H25-A-1	RECEIVER-TRANSMITTER (RT-528E-1) VOR/ILS INDICATOR (IN-525B) INSTL COMPONENTS SAME AS H22-A-1 CESSNA 300 NAV/COM 360 CHANNEL COM VOR/LOC 2ND UNIT INSTALLATION RECEIVER-TRANSMITTER (RT-308C) VOR/LOC INDICATOR (IN-514B) INSTL COMPONENTS--2ND UNIT NAV/COM ANTENNA & CABLE, RH VHF COM ANTENNA COUPLER & CABLES (VOR-OMNI) MOUNTING BOX, WIRING & MISC ITEMS CESSNA 300 NAV/COM 720 CHANNEL COM VOR/LOC 2ND UNIT INSTALLATION RECEIVER-TRANSMITTER (RT-328T) VOR/LOC INDICATOR (IN-514B) INSTL COMPONENTS SAME AS H25-A-1	42430-1124 45010-2000 3910151-6 42450-1114 45010-1000 52212-1 3910150-10 43340-1124 45010-1000 3910150-12	7.0 0.7 9.7* 6.4 0.6 0.8 0.2 1.6 10.2* 6.9 0.6 10.3*	11.0 16.3 14.4* 11.0 16.3 47.4 5.0 10.8 14.3* 11.0 16.3 14.2*
H25-A-2	CESSNA 300 NAV/COM 360 CHANNEL COM VOR/LOC 2ND UNIT INSTALLATION RECEIVER-TRANSMITTER (RT-528E-1) VOR/LOC INDICATOR (IN-514B) INSTL COMPONENTS SAME AS H25-A-1 RECEIVER-TRANSMITTER (RT-528E-1) VOR/LOC INDICATOR (IN-514B) INSTL COMPONENTS SAME AS H25-A-1 EMERGENCY LOCATOR TRANSMITTER ANTENNA ASSEMBLY EMERGENCY LOCATOR TRANSMITTER (USED IN CANADA) TRANSMITTER ASSY	42430-1124 45010-2000 3910151-6 42450-1114 45010-1000 52212-1 3910150-10 43340-1124 45010-1000 3910150-12 42430-1124 45010-1000 0770135-1 C589510-0209 C589510-0203 0770135-2 C589510-0212 C589510-0203	7.0 0.6 2.0* 1.8 0.1 1.8* 1.6 0.1 12.2* 1.1 0.6 7.8 13.0* 1.6 0.8 0.6 7.8 0.8 0.2	11.0 16.3 14.4* 11.0 16.3 47.4 5.0 10.8 14.3* 11.0 16.3 134.6* 134.5 137.8 134.6* 134.5 137.8 15.0 11.2 66.5 45.2* 13.0 10.8 11.2 66.5 141.8 184.6 12.0
H25-A-3	CESSNA 300 NAV/COM 360 CHANNEL COM VOR/LOC 2ND UNIT INSTALLATION RECEIVER-TRANSMITTER (RT-528E-1) VOR/LOC INDICATOR (IN-514B) INSTL COMPONENTS SAME AS H25-A-1 RECEIVER-TRANSMITTER (RT-528E-1) VOR/LOC INDICATOR (IN-514B) INSTL COMPONENTS SAME AS H25-A-1 EMERGENCY LOCATOR TRANSMITTER ANTENNA ASSEMBLY EMERGENCY LOCATOR TRANSMITTER (USED IN CANADA) TRANSMITTER ASSY	42430-1124 45010-2000 3910151-6 42450-1114 45010-1000 52212-1 3910150-10 43340-1124 45010-1000 3910150-12 42430-1124 45010-1000 0770135-1 C589510-0209 C589510-0203 0770135-2 C589510-0212 C589510-0203	7.0 0.6 2.0* 1.8 0.1 1.8* 1.6 0.1 12.2* 1.1 0.6 7.8 13.0* 1.6 0.8 0.6 7.8 0.8 0.2	11.0 16.3 14.4* 11.0 16.3 47.4 5.0 10.8 14.3* 11.0 16.3 134.6* 134.5 137.8 134.6* 134.5 137.8 15.0 11.2 66.5 45.2* 13.0 10.8 11.2 66.5 141.8 184.6 12.0
H28-A-1	RECEIVER-TRANSMITTER (RT-528E-1) VOR/ILS INDICATOR (IN-525B) INSTL COMPONENTS SAME AS H22-A-1 CESSNA 300 NAV/COM 360 CHANNEL COM VOR/LOC 2ND UNIT INSTALLATION RECEIVER-TRANSMITTER (RT-308C) VOR/LOC INDICATOR (IN-514B) INSTL COMPONENTS--2ND UNIT NAV/COM ANTENNA & CABLE, RH VHF COM ANTENNA COUPLER & CABLES (VOR-OMNI) MOUNTING BOX, WIRING & MISC ITEMS CESSNA 300 NAV/COM 720 CHANNEL COM VOR/LOC 2ND UNIT INSTALLATION RECEIVER-TRANSMITTER (RT-328T) VOR/LOC INDICATOR (IN-514B) INSTL COMPONENTS SAME AS H25-A-1	42430-1124 45010-2000 3910151-6 42450-1114 45010-1000 52212-1 3910150-10 43340-1124 45010-1000 3910150-12 42430-1124 45010-1000 0770135-1 C589510-0209 C589510-0203 0770135-2 C589510-0212 C589510-0203	7.0 0.6 2.0* 1.8 0.1 1.8* 1.6 0.1 12.2* 1.1 0.6 7.8 13.0* 1.6 0.8 0.6 7.8 0.8 0.2	11.0 16.3 14.4* 11.0 16.3 47.4 5.0 10.8 14.3* 11.0 16.3 134.6* 134.5 137.8 134.6* 134.5 137.8 15.0 11.2 66.5 45.2* 13.0 10.8 11.2 66.5 141.8 184.6 12.0
H28-A-2	CESSNA 300 NAV/COM 360 CHANNEL COM VOR/LOC 2ND UNIT INSTALLATION RECEIVER-TRANSMITTER (RT-528E-1) VOR/LOC INDICATOR (IN-514B) INSTL COMPONENTS SAME AS H25-A-1 RECEIVER-TRANSMITTER (RT-528E-1) VOR/LOC INDICATOR (IN-514B) INSTL COMPONENTS SAME AS H25-A-1 EMERGENCY LOCATOR TRANSMITTER ANTENNA ASSEMBLY EMERGENCY LOCATOR TRANSMITTER (USED IN CANADA) TRANSMITTER ASSY	42430-1124 45010-2000 3910151-6 42450-1114 45010-1000 52212-1 3910150-10 43340-1124 45010-1000 3910150-12 42430-1124 45010-1000 0770135-1 C589510-0209 C589510-0203 0770135-2 C589510-0212 C589510-0203	7.0 0.6 2.0* 1.8 0.1 1.8* 1.6 0.1 12.2* 1.1 0.6 7.8 13.0* 1.6 0.8 0.6 7.8 0.8 0.2	11.0 16.3 14.4* 11.0 16.3 47.4 5.0 10.8 14.3* 11.0 16.3 134.6* 134.5 137.8 134.6* 134.5 137.8 15.0 11.2 66.5 45.2* 13.0 10.8 11.2 66.5 141.8 184.6 12.0
H31-A-1	NAV-CONTROL 200A INSTALLATION (AF-295B) TURN COORDINATOR (D88-O-1)(NET CHANGE) WING SERVO INSTALLATION (AF-395-A) NAV-0-MATIC 300A INSTALLATION (AF-395-A) CONTROLLER-AMPLIFIER (C-395A) GYRO INSTALLATION (NET CHANGE) TURN COORDINATOR (D88-O-1)(NET CHANGE) WING SERVO INSTALLATION AVIONICS OPT F (ADF ANTI-PRECIP ANTENNA) AVIONICS OPTION G (FLUSH MTD COM ANTENNA) (FLUSH MID IN LEAD EDGE VERTICAL FIN HEADSET-MIKE COMBINATION	42660-1000 0701038 42320-0014 0700215 3910115-26 3910115 3970111-1	1.6 0.1 12.2* 1.1 0.6 7.8 13.0* 1.6 0.8 0.6 7.8 0.8 0.2	134.5 137.8 147.5* 15.0 11.2 66.5 45.2* 13.0 10.8 11.2 66.5 141.8 184.6 12.0
H31-A-2	NAV-CONTROL 200A INSTALLATION (AF-295B) TURN COORDINATOR (D88-O-1)(NET CHANGE) WING SERVO INSTALLATION (AF-395-A) NAV-0-MATIC 300A INSTALLATION (AF-395-A) CONTROLLER-AMPLIFIER (C-395A) GYRO INSTALLATION (NET CHANGE) TURN COORDINATOR (D88-O-1)(NET CHANGE) WING SERVO INSTALLATION AVIONICS OPT F (ADF ANTI-PRECIP ANTENNA) AVIONICS OPTION G (FLUSH MTD COM ANTENNA) (FLUSH MID IN LEAD EDGE VERTICAL FIN HEADSET-MIKE COMBINATION	42660-1000 0701038 42320-0014 0700215 3910115-26 3910115 3970111-1	1.6 0.1 12.2* 1.1 0.6 7.8 13.0* 1.6 0.8 0.6 7.8 0.8 0.2	134.5 137.8 147.5* 15.0 11.2 66.5 45.2* 13.0 10.8 11.2 66.5 141.8 184.6 12.0
H46-A	NAV-CONTROL 200A INSTALLATION (AF-295B) TURN COORDINATOR (D88-O-1)(NET CHANGE) WING SERVO INSTALLATION (AF-395-A) NAV-0-MATIC 300A INSTALLATION (AF-395-A) CONTROLLER-AMPLIFIER (C-395A) GYRO INSTALLATION (NET CHANGE) TURN COORDINATOR (D88-O-1)(NET CHANGE) WING SERVO INSTALLATION AVIONICS OPT F (ADF ANTI-PRECIP ANTENNA) AVIONICS OPTION G (FLUSH MTD COM ANTENNA) (FLUSH MID IN LEAD EDGE VERTICAL FIN HEADSET-MIKE COMBINATION	42660-1000 0701038 42320-0014 0700215 3910115-26 3910115 3970111-1	1.6 0.1 12.2* 1.1 0.6 7.8 13.0* 1.6 0.8 0.6 7.8 0.8 0.2	134.5 137.8 147.5* 15.0 11.2 66.5 45.2* 13.0 10.8 11.2 66.5 141.8 184.6 12.0
H52-A	NAV-CONTROL 200A INSTALLATION (AF-295B) TURN COORDINATOR (D88-O-1)(NET CHANGE) WING SERVO INSTALLATION (AF-395-A) NAV-0-MATIC 300A INSTALLATION (AF-395-A) CONTROLLER-AMPLIFIER (C-395A) GYRO INSTALLATION (NET CHANGE) TURN COORDINATOR (D88-O-1)(NET CHANGE) WING SERVO INSTALLATION AVIONICS OPT F (ADF ANTI-PRECIP ANTENNA) AVIONICS OPTION G (FLUSH MTD COM ANTENNA) (FLUSH MID IN LEAD EDGE VERTICAL FIN HEADSET-MIKE COMBINATION	42660-1000 0701038 42320-0014 0700215 3910115-26 3910115 3970111-1	1.6 0.1 12.2* 1.1 0.6 7.8 13.0* 1.6 0.8 0.6 7.8 0.8 0.2	134.5 137.8 147.5* 15.0 11.2 66.5 45.2* 13.0 10.8 11.2 66.5 141.8 184.6 12.0
H55-A	NAV-CONTROL 200A INSTALLATION (AF-295B) TURN COORDINATOR (D88-O-1)(NET CHANGE) WING SERVO INSTALLATION (AF-395-A) NAV-0-MATIC 300A INSTALLATION (AF-395-A) CONTROLLER-AMPLIFIER (C-395A) GYRO INSTALLATION (NET CHANGE) TURN COORDINATOR (D88-O-1)(NET CHANGE) WING SERVO INSTALLATION AVIONICS OPT F (ADF ANTI-PRECIP ANTENNA) AVIONICS OPTION G (FLUSH MTD COM ANTENNA) (FLUSH MID IN LEAD EDGE VERTICAL FIN HEADSET-MIKE COMBINATION	42660-1000 0701038 42320-0014 0700215 3910115-26 3910115 3970111-1	1.6 0.1 12.2* 1.1 0.6 7.8 13.0* 1.6 0.8 0.6 7.8 0.8 0.2	134.5 137.8 147.5* 15.0 11.2 66.5 45.2* 13.0 10.8 11.2 66.5 141.8 184.6 12.0

ITEM NO	EQUIPMENT LIST DESCRIPTION	REF DRAWING	WT LBS	ARM INS
J01-A	<p>J. SPECIAL OPTION PACKAGES</p> <p>SKYLANE II KIT C07-A GROUND SERVICE RECEPTACLE C19-0 HEATED PITOT &amp; STALL WARNING C31-A COURTESY ENTRANCE LIGHTS (2) C40-A NAV LIGHT DETECTORS D01-0 FLASHING BEACON LIGHT D04-A TRUE AIRSPEED IND. (NET CHANGE) E88-A DUAL STATIC ALTERNATE AIR SOURCE G92-A DUAL CNTRL H01-A-1 CESSNA 300 WING (R-546E) H19-A-1 CESSNA 300 TRANSPONDER (RT359A) H28-A-2 CESSNA 300 NAV/COM (RT-328T) H31-A-1 EMERGENCY LOCATOR TRANSMITTER NAV-PAC (SKYLANE II ONLY) (NET CHANGE) H07-A 400 GLIDESLOPE (R-443B) H12-A 400 MARKER BEACON (R-402A) H22-A-2 NAV/COM 328T VOR/LOC 1ST UNIT H22-A-1 DELETED H22-A-3 NAV/COM 328T VOR/ILS 1ST UNIT H25-A-2 NAV/COM 328T VOR/LOC 2ND UNIT ADDED</p>	<p>0700800 0701019-1 0770724-1 0770724 0701013 0701042 0701028-1 0701028-1 0760101 0720700 3910159-1 3910127-6 3910150-9 3910135-1 3910140-9 3910138-5 3910119-6 3910142-5 3910150-9  3910152-11 3910150-10</p>	<p>64.1* 3.2 0.5 NEGL 1.8 0.2 0.7 8.7 7.0 3.6 16.8 12.0 12.7* 15.9 2.5 -16.8  16.9 10.2</p>	<p>40.7* -26.5 61.7 208.5 16.4 16.4 56.5 23.6 32.0 134.6 47.5 105.2 91.4 37.0  31.9 14.3</p>
J04-A				



# SECTION 7 AIRPLANE & SYSTEMS DESCRIPTIONS

## TABLE OF CONTENTS

	Page
Introduction . . . . .	7-3
Airframe . . . . .	7-3
Flight Controls . . . . .	7-8
Trim Systems . . . . .	7-8
Instrument Panel . . . . .	7-8
Ground Control . . . . .	7-9
Wing Flap System . . . . .	7-9
Landing Gear System . . . . .	7-10
Baggage Compartment . . . . .	7-10
Seats . . . . .	7-11
Seat Belts and Shoulder Harnesses . . . . .	7-12
Seat Belts . . . . .	7-12
Shoulder Harnesses . . . . .	7-12
Integrated Seat Belt/Shoulder Harnesses With Inertia Reels . . . . .	7-14
Entrance Doors and Cabin Windows . . . . .	7-14
Control Locks . . . . .	7-15
Engine . . . . .	7-16
Engine Controls . . . . .	7-16
Engine Instruments . . . . .	7-16
New Engine Break-in and Operation . . . . .	7-17
Engine Oil System . . . . .	7-18
Ignition-Starter System . . . . .	7-19
Air Induction System . . . . .	7-19
Exhaust System . . . . .	7-19
Carburetor and Priming System . . . . .	7-19
Cooling System . . . . .	7-20
Propeller . . . . .	7-20
Fuel System . . . . .	7-21
Brake System . . . . .	7-24
Electrical System . . . . .	7-24
Master Switch . . . . .	7-26
Ammeter . . . . .	7-26

## TABLE OF CONTENTS (Continued)

	Page
Over-Voltage Sensor and Warning Light . . . . .	7-26
Circuit Breakers and Fuses . . . . .	7-27
Ground Service Plug Receptacle . . . . .	7-27
Lighting Systems . . . . .	7-28
Exterior Lighting . . . . .	7-28
Interior Lighting . . . . .	7-28
Cabin Heating, Ventilating and Defrosting System . . . . .	7-30
Pitot-Static System and Instruments . . . . .	7-32
Airspeed Indicator . . . . .	7-32
Rate-of-Climb Indicator . . . . .	7-33
Altimeter . . . . .	7-33
Vacuum System and Instruments . . . . .	7-33
Attitude Indicator . . . . .	7-33
Directional Indicator . . . . .	7-35
Suction Gage . . . . .	7-35
Stall Warning System . . . . .	7-35
Avionics Support Equipment . . . . .	7-35
Audio Control Panel . . . . .	7-37
Transmitter Selector Switch . . . . .	7-37
Automatic Audio Selector Switch . . . . .	7-38
Audio Selector Switches . . . . .	7-38
Localizer Reverse Sensing (Back-Course) Switch . . . . .	7-39
Autopilot Navigation Receiver Selector Switch . . . . .	7-39
Microphone - Headset . . . . .	7-39
Static Dischargers . . . . .	7-39



## INTRODUCTION

This section provides description and operation of the airplane and its systems. Some equipment described herein is optional and may not be installed in the airplane. Refer to Section 9, Supplements, for details of other optional systems and equipment.

## AIRFRAME

The construction of the fuselage is a conventional formed sheet metal bulkhead, stringer, and skin design referred to as semi-monocoque. Major items of structure are the front and rear carry-through spars to which the wings are attached, a bulkhead and forgings for main landing gear attachment at the base of the rear doorposts, and a bulkhead with attaching plates at the base of the forward doorposts for the lower attachment of the wing struts. Four engine mount stringers are also attached to the forward doorposts and extend forward to the firewall.

The externally braced wings, containing the fuel tanks, are constructed of a front and rear spar with formed sheet metal ribs, doublers, and stringers. The entire structure is covered with aluminum skin. The front spars are equipped with wing-to-fuselage and wing-to-strut attach fittings. The aft spars are equipped with wing-to-fuselage attach fittings, and are partial-span spars. Conventional hinged ailerons and single-slotted flaps are attached to the trailing edge of the wings. The ailerons are constructed of a forward spar containing a balance weight, formed sheet metal ribs and "V" type corrugated aluminum skin joined together at the trailing edge. The flaps are constructed basically the same as the ailerons, with the exception of the balance weight, and the addition of a formed sheet metal leading edge section.

The empennage (tail assembly) consists of a conventional vertical stabilizer, rudder, horizontal stabilizer, and elevator. The vertical stabilizer consists of a forward and aft spar, formed sheet metal ribs and reinforcements, four skin panels, formed leading edge skins, and a dorsal. The rudder is constructed of a forward and aft spar, formed sheet metal ribs and reinforcements, and a wrap-around skin panel. The top of the rudder incorporates a leading edge extension which contains a balance weight. The horizontal stabilizer is constructed of a forward and aft spar, ribs and stiffeners, center upper and lower skin panels, and two left and two right wrap-around skin panels which also form the leading edges. The horizontal stabilizer also contains the elevator trim tab actuator. Construction of the elevator consists of formed leading edge skins, a forward spar, ribs, torque tube and bellcrank, left upper and lower "V" type corrugated skins, and right upper and lower "V" type corrugated

AILERON CONTROL SYSTEM

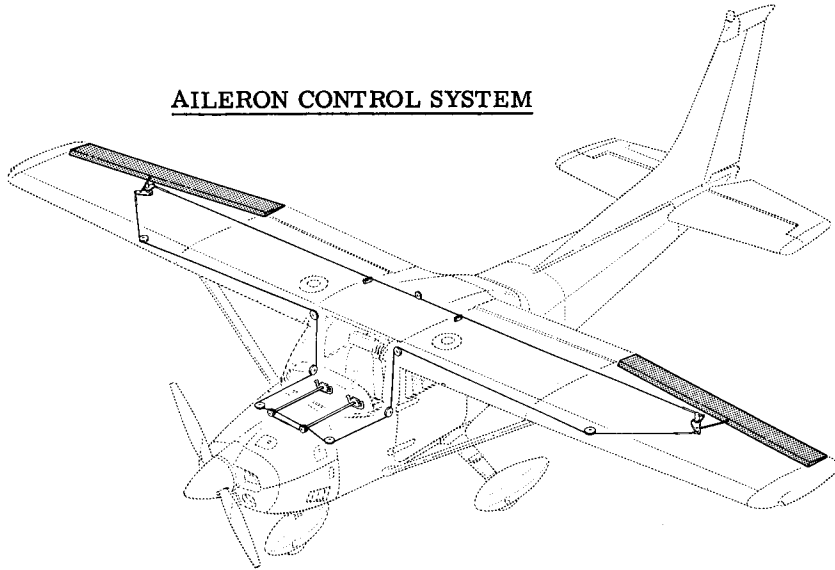

RUDDER AND RUDDER TRIM  
CONTROL SYSTEMS

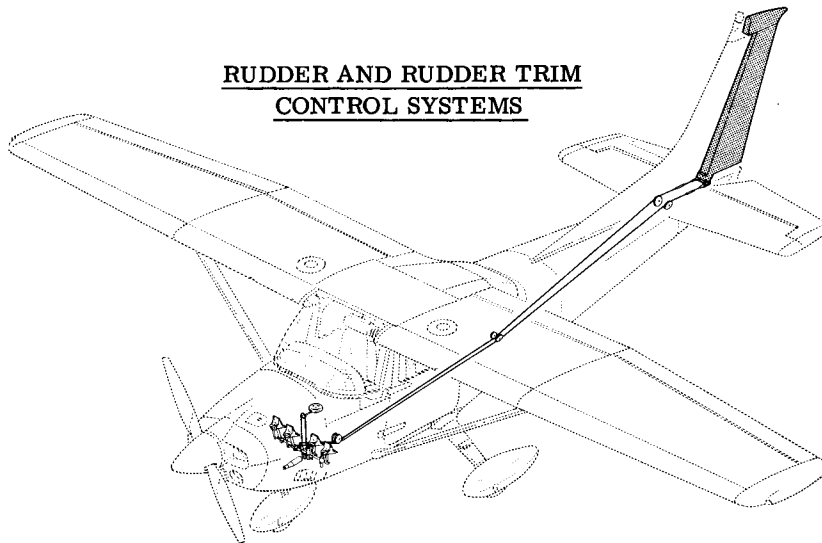
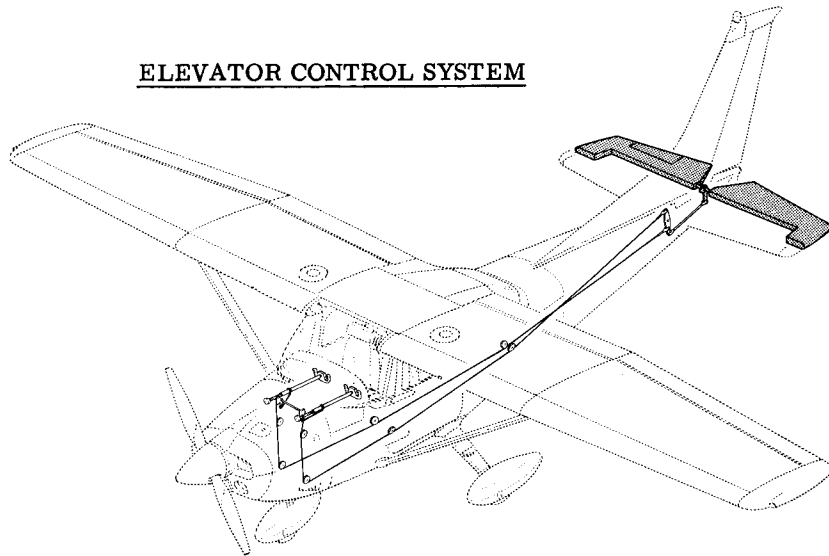

Figure 7-1. Flight Control and Trim Systems (Sheet 1 of 2)

ELEVATOR CONTROL SYSTEM



ELEVATOR TRIM CONTROL SYSTEM

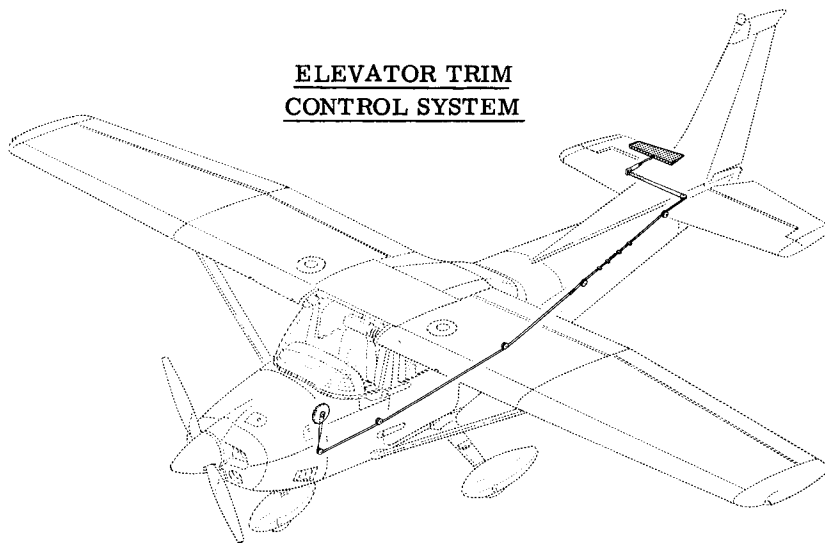

Figure 7-1. Flight Control and Trim Systems (Sheet 2 of 2)

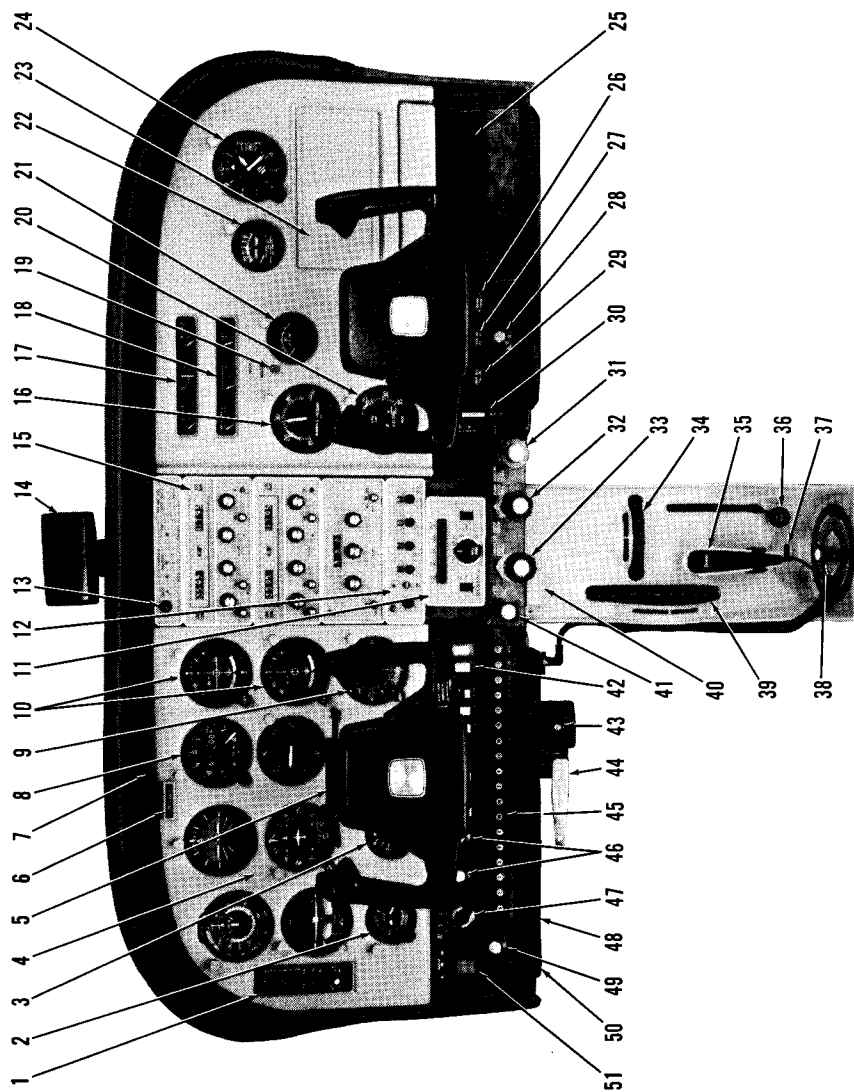

Figure 7-2. Instrument Panel (Sheet 1 of 2)

- |                                    |                                   |
|------------------------------------|-----------------------------------|
| 1. Marker Beacon Indicator         | 25. Map Compartment               |
| 2. Lights and Switches             | 26. Defroster Control Knob        |
| 3. Suction Gage                    | 27. Cabin Air Control Knob        |
| 4. Flight Instrument Group         | 28. Cigar Lighter                 |
| 5. Approach Plate Holder           | 29. Cabin Heat Control Knob       |
| 6. Airplane Registration Number    | 30. Wing Flap Switch and          |
| 7. Approach Plate Light and Switch | Position Indicator                |
| 8. Encoding Altimeter              | 31. Mixture Control Knob          |
| 9. ADF Bearing Indicator           | 32. Propeller Control Knob        |
| 10. Omni Course Indicators         | 33. Throttle (With Friction Lock) |
| 11. Autopilot Control Unit         | 34. Rudder Trim Control Wheel     |
| 12. Transponder                    | 35. Microphone                    |
| 13. Audio Control Panel            | 36. Cowl Flap Control Lever       |
| 14. Rear View Mirror               | 37. Fuel Selector Light           |
| 15. Radios                         | 38. Fuel Selector Valve Handle    |
| 16. Manifold Pressure Gage         | 39. Elevator Trim Control Wheel   |
| 17. Fuel Quantity Indicators       | 40. Control Pedestal Light        |
| and Ammeter                        | 41. Carburetor Heat Control Knob  |
| 18. Cylinder Head Temperature,     | 42. Electrical Switches           |
| Oil Temperature, and Oil           | 43. Static Pressure Alternate     |
| Pressure Gages                     | Source Valve                      |
| 19. Over-Voltage Warning Light     | 44. Parking Brake Handle          |
| 20. Tachometer                     | 45. Circuit Breakers              |
| 21. Economy Mixture Indicator      | 46. Instrument and Radio Dial     |
| 22. Carburetor Air Temperature     | Light Rheostat Control Knobs      |
| Gage                               | 47. Ignition Switch               |
| 23. Additional Radio and           | 48. Auxiliary Mike Jack           |
| Instrument Space                   | 49. Primer                        |
| 24. Secondary Altimeter            | 50. Phone Jack                    |
|                                    | 51. Master Switch                 |

Figure 7-2. Instrument Panel (Sheet 2 of 2)

skins incorporating a trailing edge cut-out for the trim tab. The elevator trim tab consists of a spar and upper and lower "V" type corrugated skins. Both elevator tip leading edge extensions incorporate balance weights.

## FLIGHT CONTROLS

The airplane's flight control system consists of conventional aileron, rudder, and elevator control surfaces (see figure 7-1). The control surfaces are manually operated through mechanical linkage using a control wheel for the ailerons and elevator, and rudder/brake pedals for the rudder.

### TRIM SYSTEMS

Manually-operated rudder and elevator trim is provided. Rudder trimming is accomplished through the rudder control system (see figure 7-1) by rotating the horizontally mounted trim control wheel either left or right, which will offset the rudder. Elevator trimming is accomplished through the elevator trim tab by utilizing the vertically mounted trim control wheel. Upward rotation of the trim wheel will trim nose-down; conversely, downward rotation will trim nose-up. The airplane may also be equipped with an electric elevator trim system. For details concerning this system, refer to Section 9, Supplements.

## INSTRUMENT PANEL

The instrument panel (see figure 7-2) is designed around the basic "T" configuration. The gyros are located immediately in front of the pilot, and arranged vertically over the control column. The airspeed indicator and altimeter are located to the left and right of the gyros, respectively. The remainder of the flight instruments are located around the basic "T". Avionics equipment is stacked approximately on the centerline of the panel, with the right side of the panel containing the wing flap switch and indicator, manifold pressure gage, tachometer, map compartment, and space for additional instruments and avionics equipment. The engine instrument cluster and fuel quantity indicators are on the right side of the avionics stack near the top of the panel. A switch and control panel, at the lower edge of the instrument panel, contains most of the switches, controls, and circuit breakers necessary to operate the airplane. The left side of the panel contains the master switch, engine primer, ignition switch, light intensity controls, electrical switches, and circuit breakers. The center area contains the carburetor heat control, throttle, propeller control, and mixture control. The right side of the panel contains the cabin heat, cabin air, and defroster control knobs and the cigar lighter.

A pedestal, extending from the switch and control panel to the floorboard, contains the elevator and rudder trim control wheels, cowl flap control lever, and microphone bracket. The fuel selector valve handle is located at the base of the pedestal. A parking brake handle is mounted under the switch and control panel, in front of the pilot. An alternate static source valve control knob may also be installed beneath the switch and control panel.

For details concerning the instruments, switches, circuit breakers, and controls on this panel, refer in this section to the description of the systems to which these items are related.

## GROUND CONTROL

Effective ground control while taxiing is accomplished through nose wheel steering by using the rudder pedals; left rudder pedal to steer left and right rudder pedal to steer right. When a rudder pedal is depressed, a spring-loaded steering bungee (which is connected to the nose gear and to the rudder bars) will turn the nose wheel through an arc of approximately  $11^\circ$  each side of center. By applying either left or right brake, the degree of turn may be increased up to  $29^\circ$  each side of center.

Moving the airplane by hand is most easily accomplished by attaching a tow bar to the nose gear strut. If a tow bar is not available, or pushing is required, use the wing struts as push points. Do not use the vertical or horizontal surfaces to move the airplane. If the airplane is to be towed by vehicle, never turn the nose wheel more than  $29^\circ$  either side of center or structural damage to the nose gear could result.

The minimum turning radius of the airplane, using differential braking and nose wheel steering during taxi, is approximately 27 feet. To obtain a minimum radius turn during ground handling, the airplane may be rotated around either main landing gear by pressing down on a tailcone bulkhead just forward of the horizontal stabilizer to raise the nose wheel off the ground.

## WING FLAP SYSTEM

The wing flaps are of the single-slot type (see figure 7-3), and are extended or retracted by positioning the wing flap switch lever on the instrument panel to the desired flap deflection position. The switch lever is moved up or down in a slotted panel that provides mechanical stops at the  $10^\circ$  and  $20^\circ$  positions. For flap settings greater than  $10^\circ$ , move the switch lever to the right to clear the stop and position it as desired. A

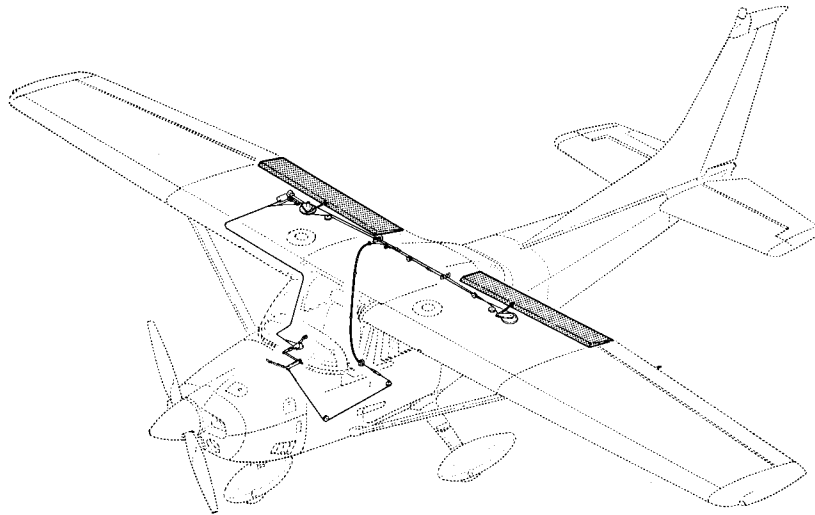

Figure 7-3. Wing Flap System

scale and pointer on the left side of the switch lever indicates flap travel in degrees. The wing flap system circuit is protected by a 15-ampere circuit breaker, labeled FLAP, on the left side of the instrument panel.

## LANDING GEAR SYSTEM

The landing gear is of the tricycle type with a steerable nose wheel, two main wheels, and wheel fairings. Shock absorption is provided by the tubular spring-steel main landing gear struts and the air/oil nose gear shock strut. Each main gear wheel is equipped with a hydraulically actuated disc-type brake on the inboard side of each wheel, and an aerodynamic fairing over each brake.

## BAGGAGE COMPARTMENT

The baggage compartment consists of the area from the back of the rear passenger seats to the aft cabin bulkhead. Mounted to the aft cabin bulkhead, and extending aft of it, is a hatshelf. Access to the baggage compartment and the hatshelf is gained through a lockable baggage door on the left side of the airplane, or from within the airplane cabin. A baggage net with six tie-down straps is provided for securing baggage and is attached by tying the straps to tie-down rings provided in the airplane. A



cargo tie-down kit may also be installed. For further information on baggage and cargo tie-down, refer to Section 6. When loading the airplane, children should not be placed or permitted in the baggage compartment, and any material that might be hazardous to the airplane or occupants should not be placed anywhere in the airplane. For baggage area and door dimensions, refer to Section 6.

## SEATS

The seating arrangement consists of two separate adjustable seats for the pilot and front passenger, a split-backed fixed seat in the rear, and a child's seat (if installed) aft of the rear seats. The pilot's and front passenger's seats are available in two different designs: four-way and six-way adjustable.

Four-way seats may be moved forward or aft, and the seat back angle changed. To position either seat, lift the tubular handle under the center of the seat, slide the seat into position, release the handle, and check that the seat is locked in place. The seat back is spring-loaded to the vertical position. To adjust its position, lift the lever under the right front corner of the seat, reposition the back, release the lever, and check that the back is locked in place. The seat backs will also fold full forward.

The six-way seats may be moved forward or aft, adjusted for height, and the seat back angle is infinitely adjustable. Position the seat by lifting the tubular handle, under the center of the seat bottom, and slide the seat into position; then release the lever and check that the seat is locked in place. Raise or lower the seat by rotating a large crank under the right corner of the left seat and the left corner of the right seat. Seat back angle is adjustable by rotating a small crank under the left corner of the left seat and the right corner of the right seat. The seat bottom angle will change as the seat back angle changes, providing proper support. The seat backs will also fold full forward.

The rear passenger's seats consist of a fixed one-piece seat bottom with individually adjustable seat backs. Two adjustment levers, on the left and right rear corners of the seat bottom, are used to adjust the angle of the respective seat backs. To adjust either seat back, lift the adjustment lever and reposition the back. The seat backs are spring-loaded to the vertical position.

A child's seat may be installed aft of the rear passenger seats, and is held in place by two brackets mounted on the floorboard. The seat is designed to swing upward into a stowed position against the aft cabin bulkhead when not in use. To stow the seat, rotate the seat bottom up and aft

as far as it will go. When not in use, the seat should be kept in the stowed position.

Headrests are available for any of the seat configurations except the child's seat. To adjust the headrest, apply enough pressure to it to raise or lower it to the desired level. The headrest may be removed at any time by raising it until it disengages from the top of the seat back.

## **SEAT BELTS AND SHOULDER HARNESSSES**

All seat positions are equipped with seat belts (see figure 7-4). The pilot's and front passenger's seats are also equipped with separate shoulder harnesses; separate shoulder harnesses are also available for the rear seat positions. Integrated seat belt/shoulder harnesses with inertia reels can be furnished for the pilot's and front passenger's seat positions if desired.

### **SEAT BELTS**

The seat belts used with the pilot's and front passenger's seats, and the child's seat (if installed), are attached to fittings on the floorboard. The buckle half is inboard of each seat and the link half is outboard of each seat. The belts for the rear seat are attached to the seat frame, with the link halves on the left and right sides of the seat bottom, and the buckles at the center of the seat bottom.

To use the seat belts for the front seats, position the seat as desired, and then lengthen the link half of the belt as needed by grasping the sides of the link and pulling against the belt. Insert and lock the belt link into the buckle. Tighten the belt to a snug fit. Seat belts for the rear seats, and the child's seat, are used in the same manner as the belts for the front seats. To release the seat belts, grasp the top of the buckle opposite the link and pull upward.

### **SHOULDER HARNESSSES**

Each front seat shoulder harness is attached to a rear doorpost above the window line and is stowed behind a stowage sheath above the cabin door. To stow the harness, fold it and place it behind the sheath. When rear seat shoulder harnesses are furnished, they are attached adjacent to the lower corners of the aft side windows. Each rear seat harness is stowed behind a stowage sheath above an aft side window. No harness is available for the child's seat.

To use a front or rear seat shoulder harness, fasten and adjust the

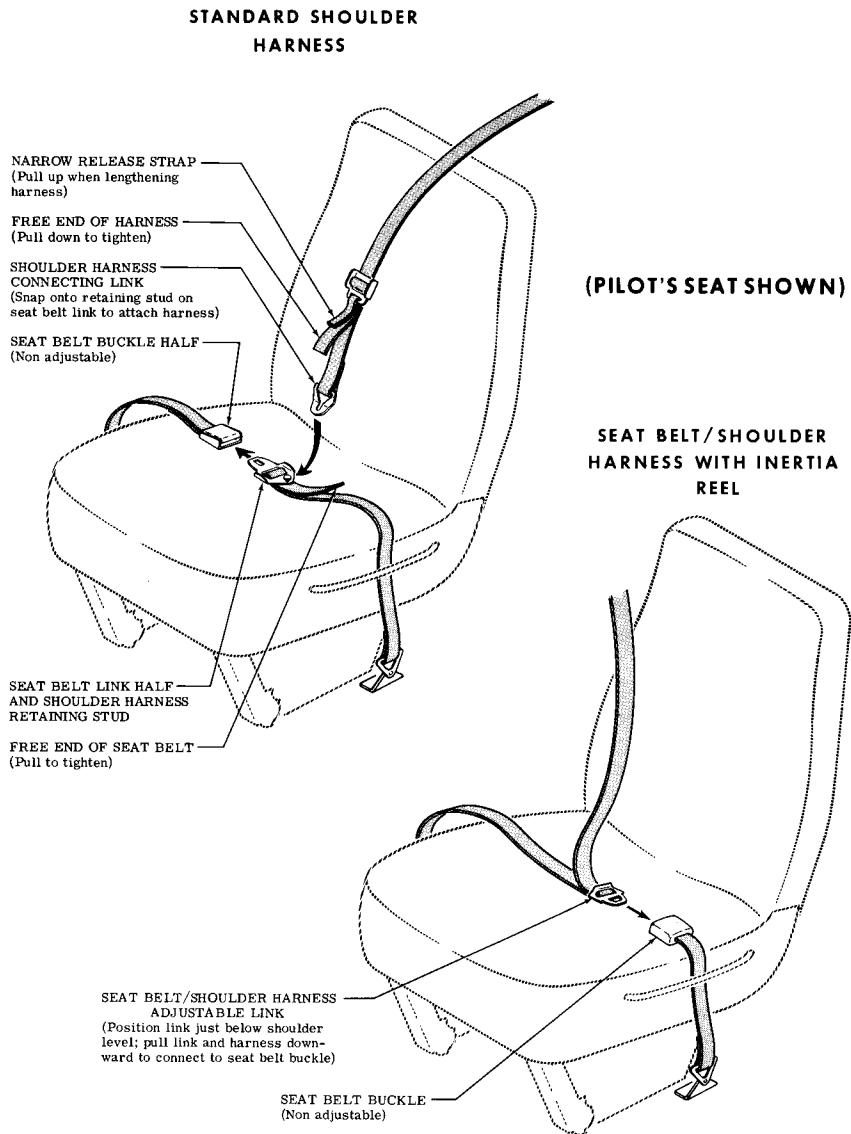

Figure 7-4. Seat Belts and Shoulder Harnesses

seat belt first. Lengthen the harness as required by pulling on the connecting link on the end of the harness and the narrow release strap. Snap the connecting link firmly onto the retaining stud on the seat belt link half. Then adjust to length. A properly adjusted harness will permit the occupant to lean forward enough to sit completely erect, but prevent excessive forward movement and contact with objects during sudden deceleration. Also, the pilot will want the freedom to reach all controls easily.

Removing the shoulder harness is accomplished by pulling upward on the narrow release strap, and removing the harness connecting link from the stud on the seat belt link. In an emergency, the shoulder harness may be removed by releasing the seat belt first and allowing the harness, still attached to the link half of the seat belt, to drop to the side of the seat.

#### **INTEGRATED SEAT BELT/SHOULDER HARNESES WITH INERTIA REELS**

Integrated seat belt/shoulder harnesses with inertia reels are available for the pilot and front seat passenger. The seat belt/shoulder harnesses extend from inertia reels located in the cabin top structure, through slots in the overhead console marked PILOT and COPILOT, to attach points inboard of the two front seats. A separate seat belt half and buckle is located outboard of the seats. Inertia reels allow complete freedom of body movement. However, in the event of a sudden deceleration, they will lock automatically to protect the occupants.

To use the seat belt/shoulder harness, position the adjustable metal link on the harness at about shoulder level, pull the link and harness downward, and insert the link in the seat belt buckle. Adjust belt tension across the lap by pulling upward on the shoulder harness. Removal is accomplished by releasing the seat belt buckle, which will allow the inertia reel to pull the harness inboard of the seat.

#### **ENTRANCE DOORS AND CABIN WINDOWS**

Entry to, and exit from the airplane is accomplished through either of two entry doors, one on each side of the cabin at the front seat positions (refer to Section 6 for cabin and cabin door dimensions). The doors incorporate a recessed exterior door handle, a conventional interior door handle, a key-operated door lock (left door only), a door stop mechanism, and an openable window in the left door. An openable right door window is also available.

To open the doors from outside the airplane, utilize the recessed door handle near the aft edge of each door. Depress the forward end of the handle to rotate it out of its recess, and then pull outboard. To close or

open the doors from inside the airplane, use the combination door handle and arm rest. The inside door handle has three positions and a placard at its base which reads OPEN, CLOSE, and LOCK. The handle is spring-loaded to the CLOSE (up) position. When the door has been pulled shut and latched, lock it by rotating the door handle forward to the LOCK position (flush with the arm rest). When the handle is rotated to the LOCK position, an over-center action will hold it in that position. Both cabin doors should be locked prior to flight, and should not be opened intentionally during flight.

#### NOTE

Accidental opening of a cabin door in flight due to improper closing does not constitute a need to land the airplane. The best procedure is to set up the airplane in a trimmed condition at approximately 80 knots, open a window, momentarily shove the door outward slightly, and forcefully close and lock the door by normal procedures.

Exit from the airplane is accomplished by rotating the door handle from the LOCK position, past the CLOSE position, aft to the OPEN position and pushing the door open. To lock the airplane, lock the right cabin door with the inside handle, close the left cabin door, and using the ignition key, lock the door.

The left cabin door is equipped with an openable window which is held in the closed position by a lock button equipped over-center latch on the lower edge of the window frame. To open the window, depress the lock button and rotate the latch upward. The window is equipped with a spring-loaded retaining arm which will help rotate the window outward and hold it there. An openable window is also available for the right door, and functions in the same manner as the left window. If required, either window may be opened at any speed up to 176 knots. The cabin top windows (if installed), rear side windows, and rear window are of the fixed type and cannot be opened.

## CONTROL LOCKS

A control lock is provided to lock the ailerons and elevator control surfaces in a neutral position and prevent damage to these systems by wind buffeting while the airplane is parked. The lock consists of a shaped steel rod with a red metal flag attached to it. The flag is labeled CONTROL LOCK, REMOVE BEFORE STARTING ENGINE. To install the control lock, align the hole in the top of the pilot's control wheel shaft with the hole in the top of the shaft collar on the instrument panel and insert the rod into the aligned holes. Proper installation of the lock will place the red flag over the ignition switch. In areas where high or gusty winds

occur, a control surface lock should be installed over the vertical stabilizer and rudder. The control lock and any other type of locking device should be removed prior to starting the engine.

## ENGINE

The airplane is powered by a horizontally-opposed, six-cylinder, overhead-valve, air-cooled, carbureted engine with a wet sump oil system. The engine is a Continental Model O-470-S and is rated at 230 horsepower at 2600 RPM. Major accessories include a propeller governor on the front of the engine and dual magnetos, starter, belt-driven alternator, and vacuum pump on the rear of the engine. Provisions are also made for a full flow oil filter.

### ENGINE CONTROLS

Engine power is controlled by a throttle located on the lower center portion of the instrument panel. The throttle operates in a conventional manner; in the full forward position, the throttle is open, and in the full aft position, it is closed. A friction lock, which is a round knurled disk, is located at the base of the throttle and is operated by rotating the lock clockwise to increase friction or counterclockwise to decrease it.

The mixture control, mounted adjacent to the throttle, is a red knob with raised points around the circumference and is equipped with a lock button in the end of the knob. The rich position is full forward, and full aft is the idle cut-off position. To adjust the mixture, move the control forward or aft by depressing the lock button in the end of the control.

### ENGINE INSTRUMENTS

Engine operation is monitored by the following instruments: oil pressure gage, oil temperature gage, cylinder head temperature gage, tachometer, and manifold pressure gage. An economy mixture (EGT) indicator and carburetor air temperature gage are also available.

The oil pressure gage, located on the right side of the instrument panel, is operated by oil pressure. A direct pressure oil line from the engine delivers oil at engine operating pressure to the oil pressure gage. Gage markings indicate that minimum idling pressure is 10 PSI (red line), the normal operating range is 30 to 60 PSI (green arc), and maximum pressure is 100 PSI (red line).

Oil temperature is indicated by a gage adjacent to the oil pressure gage. The gage is operated by an electrical-resistance type temperature

sensor which receives power from the airplane electrical system. Oil temperature limitations are the normal operating range (green arc) which is 38°C (100°F) to 116°C (240°F), and the maximum (red line) which is 116°C (240°F).

The cylinder head temperature gage, under the left fuel quantity indicator, is operated by an electrical-resistance type temperature sensor on the engine which receives power from the airplane electrical system. Temperature limitations are the normal operating range (green arc) which is 93°C (200°F) to 238°C (460°F) and the maximum (red line) which is 238°C (460°F).

The engine-driven mechanical tachometer is located on the lower right side of the instrument panel. The instrument is calibrated in increments of 100 RPM and indicates both engine and propeller speed. An hour meter below the center of the tachometer dial records elapsed engine time in hours and tenths. Instrument markings include a normal operating range (green arc) of 2200 to 2450 RPM, and a maximum (red line) of 2600 RPM.

The manifold pressure gage is located on the right side of the instrument panel above the tachometer. The gage is direct reading and indicates induction air manifold pressure in inches of mercury. It has a normal operating range (green arc) of 15 to 23 inches of mercury.

An economy mixture (EGT) indicator is available for the airplane and is located on the right side of the instrument panel. A thermocouple probe in the left exhaust stack assembly measures exhaust gas temperature and transmits it to the indicator. The indicator serves as a visual aid to the pilot in adjusting cruise mixture. Exhaust gas temperature varies with fuel-to-air ratio, power, and RPM. However, the difference between the peak EGT and the EGT at the cruise mixture setting is essentially constant and this provides a useful leaning aid. The indicator is equipped with a manually positioned peak EGT reference pointer.

A carburetor air temperature gage may be installed on the right side of the instrument panel to help detect carburetor icing conditions. The gage is marked in 5° increments from -30°C to +30°C, and has a yellow arc between -15°C and +5°C which indicates the temperature range most conducive to icing in the carburetor. A placard on the lower half of the gage face reads KEEP NEEDLE OUT OF YELLOW ARC DURING POSSIBLE CARBURETOR ICING CONDITIONS.

#### **NEW ENGINE BREAK-IN AND OPERATION**

The engine underwent a run-in at the factory and is ready for the full range of use. It is, however, suggested that cruising be accomplished at

65% to 75% power until a total of 50 hours has accumulated or oil consumption has stabilized. This will ensure proper seating of the rings.

The airplane is delivered from the factory with corrosion preventive oil in the engine. If, during the first 25 hours, oil must be added, use only aviation grade straight mineral oil conforming to Specification No. MIL-L-6082.

### **ENGINE OIL SYSTEM**

Oil for engine lubrication and propeller governor operation is supplied from a sump on the bottom of the engine. The capacity of the sump is 12 quarts (one additional quart is required if a full flow oil filter is installed). Oil is drawn from the sump through a filter screen on the end of a pickup tube to the engine-driven oil pump. Oil from the pump passes through an oil pressure screen (full flow oil filter, if installed), a pressure relief valve at the rear of the right oil gallery, and a thermostatically controlled oil cooler. Oil from the cooler is then circulated to the left gallery and propeller governor. The engine parts are then lubricated by oil from the galleries. After lubricating the engine, the oil returns to the sump by gravity. If a full flow oil filter is installed, the filter adapter is equipped with a bypass valve which will cause lubricating oil to bypass the filter in the event the filter becomes plugged, or the oil temperature is extremely cold.

An oil dipstick is located at the rear of the engine on the left side, and an oil filler tube is on top of the crankcase near the front of the engine. The dipstick and oil filler are accessible through doors on the engine cowling. The engine should not be operated on less than nine quarts of oil. To minimize loss of oil through the breather, fill to 10 quarts for normal flights of less than three hours. For extended flight, fill to 12 quarts (dipstick indication only). For engine oil grade and specifications, refer to Section 8 of this handbook.

The oil cooler may be replaced by a non-congealing oil cooler for operations in temperatures consistently below  $-7^{\circ}\text{C}$  ( $20^{\circ}\text{F}$ ). The non-congealing oil cooler provides improved oil flow at low temperatures. Once installed, the non-congealing oil cooler is approved for permanent use in both hot and cold weather.

An oil quick-drain valve is available to replace the drain plug on the bottom left side of the oil sump, and provides quicker, cleaner draining of the engine oil. To drain the oil with this valve, slip a hose over the end of the valve and push upward on the end of the valve until it snaps into the open position. Spring clips will hold the valve open. After draining, use a suitable tool to snap the valve into the extended (closed) position and remove the drain hose.



### **IGNITION-STARTER SYSTEM**

Engine ignition is provided by two engine-driven magnetos, and two spark plugs in each cylinder. The right magneto fires the lower left and upper right spark plugs, and the left magneto fires the lower right and upper left spark plugs. Normal operation is conducted with both magnetos due to the more complete burning of the fuel-air mixture with dual ignition.

Ignition and starter operation is controlled by a rotary type switch located on the left switch and control panel. The switch is labeled clockwise, OFF, R, L, BOTH, and START. The engine should be operated on both magnetos (BOTH position) except for magneto checks. The R and L positions are for checking purposes and emergency use only. When the switch is rotated to the spring-loaded START position (with the master switch in the ON position), the starter contactor is energized and the starter will crank the engine. When the switch is released, it will automatically return to the BOTH position.

### **AIR INDUCTION SYSTEM**

The engine air induction system receives ram air through an intake in the lower front portion of the engine cowling. The intake is covered by an air filter which removes dust and other foreign matter from the induction air. Airflow passing through the filter enters an airbox at the front of the engine. After passing through the airbox, induction air enters the inlet in the carburetor which is under the engine, and is then ducted to the engine cylinders through intake manifold tubes. In the event carburetor ice is encountered or the intake filter becomes blocked, alternate heated air can be obtained from a shroud around an exhaust riser through a duct to a valve, in the airbox, operated by the carburetor heat control on the instrument panel. Heated air from the exhaust riser shroud is obtained from unfiltered air inside the cowling. Use of full carburetor heat at full throttle will result in a loss of approximately one to two inches of manifold pressure.

### **EXHAUST SYSTEM**

Exhaust gas from each cylinder passes through riser assemblies to a muffler and tailpipe. The muffler is constructed with a shroud around the outside which forms a heating chamber for cabin heater air.

### **CARBURETOR AND PRIMING SYSTEM**

The engine is equipped with an up-draft, float-type, fixed jet carburetor mounted on the bottom of the engine. The carburetor is equipped with an enclosed accelerator pump, simplified fuel passages to prevent

vapor locking, an idle cut-off mechanism, and a manual mixture control. Fuel is delivered to the carburetor by gravity flow from the fuel system. In the carburetor, fuel is atomized, proportionally mixed with intake air, and delivered to the cylinders through intake manifold tubes. The proportion of atomized fuel to air is controlled, within limits, by the mixture control on the instrument panel.

For easy starting in cold weather, the engine is equipped with a manual primer. The primer is actually a small pump which draws fuel from the fuel strainer when the plunger is pulled out, and injects it into the intake manifold when the plunger is pushed back in. The plunger knob, on the instrument panel, is equipped with a lock, and after being pushed full in, must be rotated either left or right until the knob cannot be pulled out.

### **COOLING SYSTEM**

Ram air for engine cooling enters through two intake openings in the front of the engine cowling. The cooling air is directed around the cylinders and other areas of the engine by baffling, and is then exhausted through cowl flaps on the lower aft edge of the cowling. The cowl flaps are mechanically operated from the cabin by means of a cowl flap lever on the right side of the control pedestal. The pedestal is labeled OPEN, COWL FLAPS, CLOSED. During takeoff and high power operation, the cowl flap lever should be placed in the OPEN position for maximum cooling. This is accomplished by moving the lever to the right to clear a detent, then moving the lever up to the OPEN position. Anytime the lever is repositioned, it must first be moved to the right. While in cruise flight, cowl flaps should be adjusted to keep the cylinder head temperature at approximately two-thirds of the normal operating range (green arc). During extended let-downs, it may be necessary to completely close the cowl flaps by pushing the cowl flap lever down to the CLOSED position.

A winterization kit is available and consists of two baffles which attach to the air intakes in the cowling nose cap, a restrictive cover plate for the induction air inlet, and insulation for the crankcase breather line. This equipment should be installed for operations in temperatures consistently below  $-7^{\circ}\text{C}$  ( $20^{\circ}\text{F}$ ). Once installed, the crankcase breather insulation is approved for permanent use in both hot and cold weather.

### **PROPELLER**

The airplane has an all-metal, two-bladed, constant-speed, governor-regulated propeller. A setting introduced into the governor with the propeller control establishes the propeller speed, and thus the engine speed to be maintained. The governor then controls flow of engine oil, boosted

to high pressure by the governing pump, to or from a piston in the propeller hub. Oil pressure acting on the piston twists the blades toward high pitch (low RPM). When oil pressure to the piston in the propeller hub is relieved, centrifugal force, assisted by an internal spring, twists the blades toward low pitch (high RPM).

A control knob on the lower center portion of the instrument panel is used to set the propeller and control engine RPM as desired for various flight conditions. The knob is labeled PROP PITCH, PUSH INCR RPM. When the control knob is pushed in, blade pitch will decrease, giving a higher RPM. When the control knob is pulled out, the blade pitch increases, thereby decreasing RPM. The propeller control knob is equipped with a vernier feature which allows slow or fine RPM adjustments by rotating the knob clockwise to increase RPM, and counterclockwise to decrease it. To make rapid or large adjustments, depress the button on the end of the control knob and reposition the control as desired.

## FUEL SYSTEM

The airplane may be equipped with either a standard fuel system or a long range system (see figure 7-6). Both systems consist of two vented fuel tanks (one in each wing), a four position selector valve, fuel strainer, manual primer, and carburetor. Refer to figure 7-5 for fuel quantity data for both systems.

Fuel flows by gravity from the two wing tanks to a four-position selector valve, labeled BOTH, RIGHT, LEFT, and OFF. With the selector valve in either the BOTH, LEFT, or RIGHT position, fuel flows through a strainer to the carburetor. From the carburetor, mixed fuel and air flows to the cylinders through intake manifold tubes. The manual primer draws its fuel from the fuel strainer and injects it into the intake manifold.

FUEL QUANTITY DATA (U. S. GALLONS)			
TANKS	TOTAL USABLE FUEL ALL FLIGHT CONDITIONS	TOTAL UNUSABLE FUEL	TOTAL FUEL VOLUME
STANDARD (30.5 Gal. Each)	56	5	61
LONG RANGE (40 Gal. Each)	75	5	80

Figure 7-5. Fuel Quantity Data

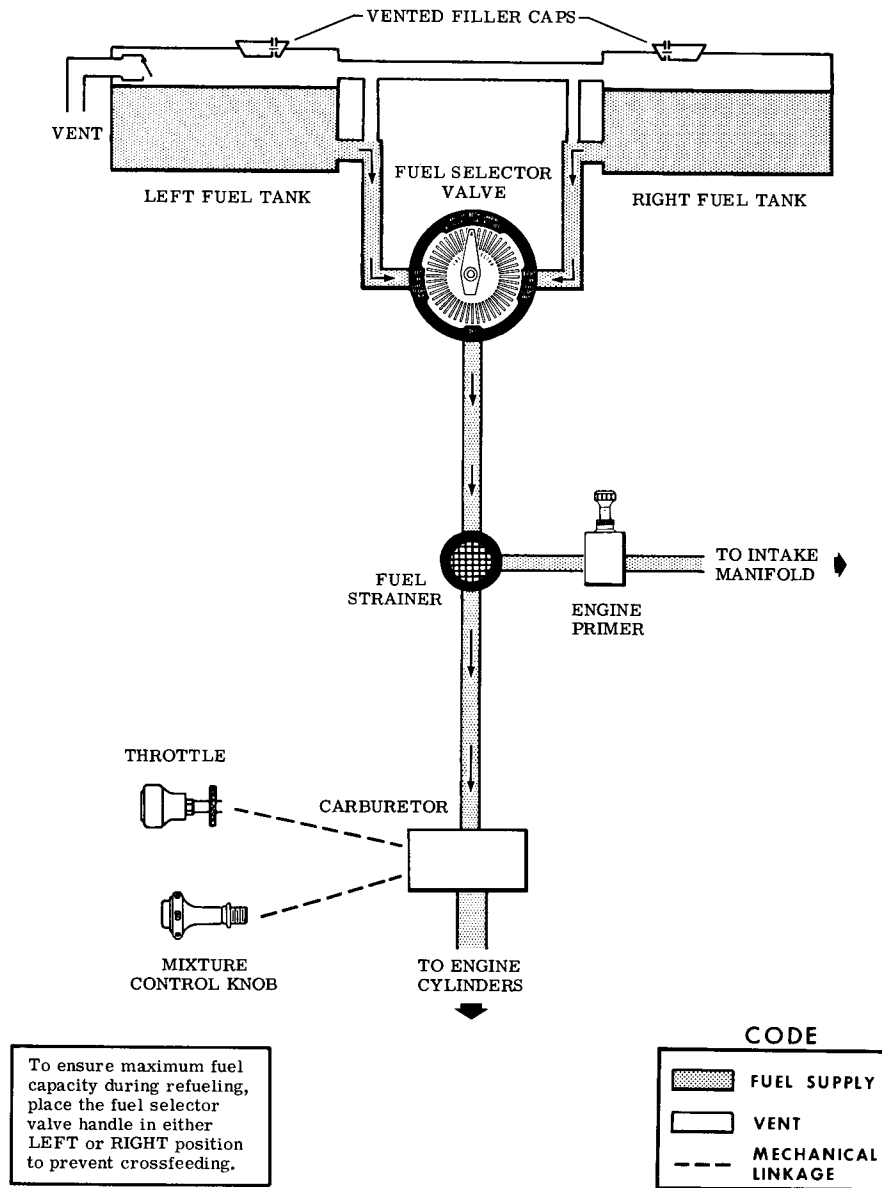

Figure 7-6. Fuel System (Standard and Long Range)

Fuel system venting is essential to system operation. Complete blockage of the venting system will result in collapsing of the bladder cells, a decreasing fuel flow and eventual engine stoppage. Venting of the right tank is accomplished by an interconnecting line from the left tank. The left fuel tank is vented overboard through a vent line which is equipped with a check valve, and protrudes from the bottom surface of the left wing near the wing strut attach point. The fuel filler caps are equipped with vacuum operated vents which open, allowing air into the tanks, should the fuel tank vent line become blocked.

Fuel quantity is measured by two float-type fuel quantity transmitters (one in each tank) and indicated by two electrically-operated fuel quantity indicators on the right side of the instrument panel. An empty tank is indicated by a red line and the letter E. When an indicator shows an empty tank, approximately 2.5 gallons remain in a standard tank, and 3 gallons remain in a long range tank as unusable fuel. The indicators cannot be relied upon for accurate readings during skids, slips, or unusual attitudes. If both indicator pointers should rapidly move to a zero reading, check the cylinder head temperature and oil temperature gages for operation. If these gages are not indicating, an electrical malfunction has occurred.

The fuel selector valve should be in the BOTH position for takeoff, climb, landing, and maneuvers that involve prolonged slips or skids. Operation from either LEFT or RIGHT tank is reserved for cruising flight.

NOTE

When the fuel selector valve handle is in the BOTH position in cruising flight, unequal fuel flow from each tank may occur if the wings are not maintained exactly level. Resulting wing heaviness can be alleviated gradually by turning the selector valve handle to the tank in the "heavy" wing.

NOTE

It is not practical to measure the time required to consume all of the fuel in one tank, and, after switching to the opposite tank, expect an equal duration from the remaining fuel. The airspace in both fuel tanks is interconnected by a vent line and, therefore, some sloshing of fuel between tanks can be expected when the tanks are nearly full and the wings are not level.

The fuel system is equipped with drain valves to provide a means for the examination of fuel in the system for contamination and grade. The system should be examined before the first flight of every day and after each refueling, by using the sampler cup provided to drain fuel from the

wing tank sumps, and by utilizing the fuel strainer drain under an access panel on the left side of the engine cowling. The fuel tanks should be filled after each flight to prevent condensation.

## **BRAKE SYSTEM**

The airplane has a single-disc, hydraulically-actuated brake on each main landing gear wheel. Each brake is connected, by a hydraulic line, to a master cylinder attached to each of the pilot's rudder pedals. The brakes are operated by applying pressure to the top of either the left (pilot's) or right (copilot's) set of rudder pedals, which are interconnected. When the airplane is parked, both main wheel brakes may be set by utilizing the parking brake which is operated by a handle under the left side of the instrument panel. To apply the parking brake, set the brakes with the rudder pedals, pull the handle aft, and rotate it 90° down.

For maximum brake life, keep the brake system properly maintained, and minimize brake usage during taxi operations and landings.

Some of the symptoms of impending brake failure are: gradual decrease in braking action after brake application, noisy or dragging brakes, soft or spongy pedals, short pedal travel and hard pedal, and excessive travel and weak braking action. If any of these symptoms appear, the brake system is in need of immediate attention. If, during taxi or landing roll, braking action decreases, let up on the pedals and then re-apply the brakes with heavy pressure. If the brakes become spongy or pedal travel increases, pumping the pedals should build braking pressure. If one brake becomes weak or fails, use the other brake sparingly while using opposite rudder, as required, to offset the good brake.

## **ELECTRICAL SYSTEM**

Electrical energy (see figure 7-7) is supplied by a 14-volt, direct-current system powered by an engine-driven, 60-amp alternator. The 12-volt, 33-amp hour battery is located in the tailcone aft of the baggage compartment wall. Power is supplied to all electrical circuits through a split bus bar, one side containing electronic system circuits and the other side having general electrical system circuits. Both sides of the bus are on at all times except when either an external power source is connected or the starter switch is turned on; then a power contactor is automatically activated to open the circuit to the electronic bus. Isolating the electronic circuits in this manner prevents harmful transient voltages from damaging the transistors in the electronic equipment.

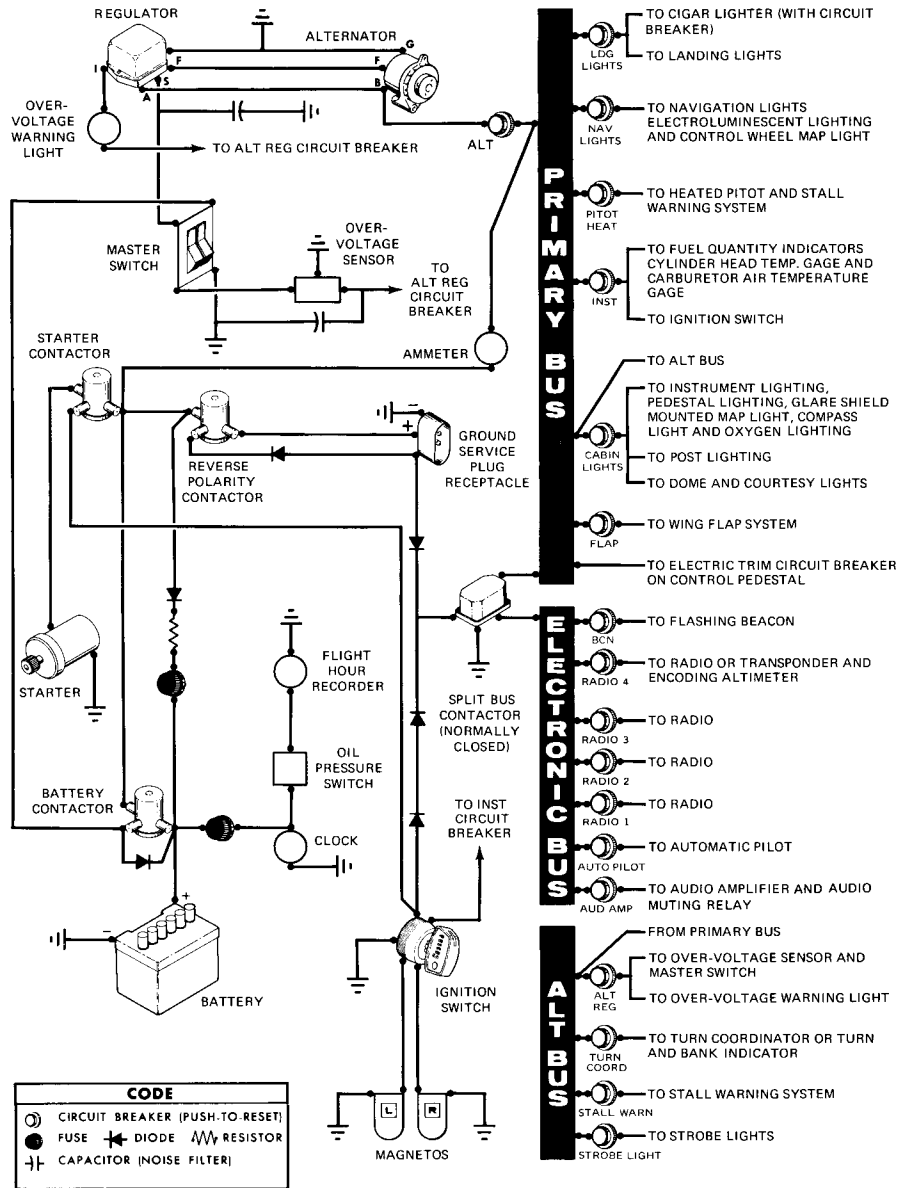

Figure 7-7. Electrical System

## **MASTER SWITCH**

The master switch is a split-rocker type switch labeled MASTER, and is ON in the up position and OFF in the down position. The right half of the switch, labeled BAT, controls all electrical power to the airplane. The left half, labeled ALT, controls the alternator.

Normally, both sides of the master switch should be used simultaneously; however, the BAT side of the switch could be turned ON separately to check equipment while on the ground. The ALT side of the switch, when placed in the OFF position, removes the alternator from the electrical system. With this switch in the OFF position, the entire electrical load is placed on the battery. Continued operation with the alternator switch in the OFF position will reduce battery power low enough to open the battery contactor, remove power from the alternator field, and prevent alternator restart.

## **AMMETER**

The ammeter indicates the flow of current, in amperes, from the alternator to the battery or from the battery to the airplane electrical system. When the engine is operating and the master switch is turned on, the ammeter indicates the charging rate applied to the battery. In the event the alternator is not functioning or the electrical load exceeds the output of the alternator, the ammeter indicates the battery discharge rate.

## **OVER-VOLTAGE SENSOR AND WARNING LIGHT**

The airplane is equipped with an automatic over-voltage protection system consisting of an over-voltage sensor behind the instrument panel and a red warning light, labeled HIGH VOLTAGE, near the manifold pressure gage.

In the event an over-voltage condition occurs, the over-voltage sensor automatically removes alternator field current and shuts down the alternator. The warning light will then turn on, indicating to the pilot that the alternator is not operating and the battery is supplying all electrical power.

The over-voltage sensor may be reset by turning the master switch off and back on again. If the warning light does not illuminate, normal alternator charging has resumed; however, if the light does illuminate again, a malfunction has occurred, and the flight should be terminated as soon as practical.

The warning light may be tested by momentarily turning off the ALT portion of the master switch and leaving the BAT portion turned on.



## CIRCUIT BREAKERS AND FUSES

Most of the electrical circuits in the airplane are protected by "push-to-reset" circuit breakers mounted on the left side of the instrument panel. Exceptions to this are the battery contactor closing (external power) circuit, clock, and flight hour recorder circuits which have fuses mounted near the battery. The control wheel map light is protected by the NAV LIGHTS circuit breaker on the instrument panel, and a fuse behind the panel. The cigar lighter is equipped with a manually reset circuit breaker, on the back of the lighter, and is also protected by the LDG LIGHTS circuit breaker.

## GROUND SERVICE PLUG RECEPTACLE

A ground service plug receptacle may be installed to permit the use of an external power source for cold weather starting and during lengthy maintenance work on the airplane electrical system (with the exception of electronic equipment). The receptacle is located behind a door on the left side of the fuselage near the aft edge of the cowling.

### NOTE

Electrical power for the airplane electrical circuits is provided through a split bus bar having all electronic circuits on one side of the bus and other electrical circuits on the other side of the bus. When an external power source is connected, a contactor automatically opens the circuit to the electronic portion of the split bus bar as a protection against damage to the transistors in the electronic equipment by transient voltages from the power source. Therefore, the external power source can not be used as a source of power when checking electronic components.

Just before connecting an external power source (generator type or battery cart), the master switch should be turned on.

The ground service plug receptacle circuit incorporates a polarity reversal protection. Power from the external power source will flow only if the ground service plug is correctly connected to the airplane. If the plug is accidentally connected backwards, no power will flow to the electrical system, thereby preventing any damage to electrical equipment.

The battery and external power circuits have been designed to completely eliminate the need to "jumper" across the battery contactor to close it for charging a completely "dead" battery. A special fused circuit in the external power system supplies the needed "jumper" across the

contacts so that with a "dead" battery and an external power source applied, turning on the master switch will close the battery contactor.

## LIGHTING SYSTEMS

### EXTERIOR LIGHTING

Conventional navigation lights are located on the wing tips and tail stinger, and dual landing lights are installed in the cowl nose cap. Additional lighting is available and includes a strobe light on each wing tip, a flashing beacon on top of the vertical stabilizer, and two courtesy lights, one under each wing, just outboard of the cabin door. The courtesy lights are operated by a switch located on the left rear door post. All exterior lights, except the courtesy lights, are controlled by rocker type switches on the left switch and control panel. The switches are ON in the up position and OFF in the down position.

The flashing beacon should not be used when flying through clouds or overcast; the flashing light reflected from water droplets or particles in the atmosphere, particularly at night, can produce vertigo and loss of orientation.

The two high intensity strobe lights will enhance anti-collision protection. However, the lights should be turned off when taxiing in the vicinity of other aircraft, or during night flight through clouds, fog or haze.

### INTERIOR LIGHTING

Instrument and control panel lighting is provided by flood, electroluminescent, and integral lighting, with post lighting also available. All light intensity is controlled by one dual rheostat, with concentric control knobs, and one single rheostat, labeled LWR PANEL, ENG-RADIO, and INSTRUMENTS respectively. Both the dual and single rheostat controls rotate clockwise from dim to bright, and are located on the left switch and control panel. If post lighting is installed, a rocker-type selector switch next to the INSTRUMENTS rheostat control is used to select either post lighting or flood lighting. The switch is labeled LIGHTS, POST, FLOOD.

The marker beacon control panel, and switches and controls on the lower part of the instrument panel are lighted by electroluminescent panels which do not require light bulbs for illumination. To utilize this lighting, turn on the NAV LIGHTS switch and adjust light intensity with the small (inner) control knob of the concentric control knobs labeled LWR PANEL, ENG-RADIO. Electroluminescent lighting is not affected by the selection of post or flood lighting.

Instrument panel flood lighting consists of four red flood lights on the underside of the anti-glare shield, and two red flood lights in the forward part of the overhead console. To use flood lighting, place the POST-FLOOD selector switch (if installed) in the FLOOD position and adjust light intensity with the INSTRUMENTS rheostat control knob.

The instrument panel may be equipped with post lights which are mounted at the edge of each instrument or control and provide direct lighting. The lights are operated by placing the POST-FLOOD selector switch in the POST position and adjusting light intensity with the INSTRUMENTS rheostat control knob. Switching to post lights will automatically turn off flood lighting.

The engine instrument cluster, radio equipment, and magnetic compass have integral lighting and operate independently of post or flood lighting. The light intensity of instrument cluster and radio equipment lighting is controlled by the large (outer) control knob of the concentric control knobs labeled LWR PANEL, ENG-RADIO. Magnetic compass lighting intensity is controlled by the INSTRUMENTS rheostat control knob.

The airplane is equipped with a dome light aft of the overhead console. The light is operated by a slide-type switch, aft of the light lens, which turns the light on when moved to the right.

The control pedestal has two integral lights and, if the airplane is equipped with oxygen, the overhead console is illuminated by post lights. Pedestal and console light intensity is controlled by the large (outer) control knob of the concentric control knobs labeled LWR PANEL, ENG-RADIO.

Map lighting is provided by overhead console map lights and an anti-glare shield mounted map light. The airplane may also be equipped with a control wheel map light. The overhead console map lights operate in conjunction with instrument panel flood lighting and consist of two openings just aft of the red instrument panel flood lights. The map light openings have sliding covers controlled by small round knobs which uncover the openings when moved toward each other. The covers should be kept closed unless the map lights are required. A map light and toggle switch, mounted in front of the pilot on the underside of the anti-glare shield, is used for illuminating approach plates or other charts when using a control wheel mounted approach plate holder. The switch is labeled MAP LIGHT, ON, OFF and light intensity is controlled by the INSTRUMENTS control knob. A map light mounted on the bottom of the pilot's control wheel (if installed) illuminates the lower portion of the cabin in front of the pilot, and is used for checking maps and other flight data during night operation. The light is utilized by turning on the NAV LIGHTS

switch, and adjusting light intensity with the rheostat control knob on the bottom of the control wheel.

The most probable cause of a light failure is a burned out bulb; however, in the event any of the lighting systems fail to illuminate when turned on, check the appropriate circuit breaker. If the circuit breaker has opened (white button popped out), and there is no obvious indication of a short circuit (smoke or odor), turn off the light switch of the affected lights, reset the breaker, and turn the switch on again. If the breaker opens again, do not reset it.

## **CABIN HEATING, VENTILATING AND DEFROSTING SYSTEM**

The temperature and volume of airflow into the cabin can be regulated to any degree desired by manipulation of the push-pull CABIN HEAT and CABIN AIR control knobs (see figure 7-8). Both control knobs are the double button type with locks to permit intermediate settings.

### **NOTE**

For improved partial heating on mild days, pull out the CABIN AIR knob slightly when the CABIN HEAT knob is out. This action increases the airflow through the system, increasing efficiency, and blends cool outside air with the exhaust manifold heated air, thus eliminating the possibility of overheating the system ducting.

For cabin ventilation, pull the CABIN AIR knob out, with the CABIN HEAT knob pushed full in. To raise the air temperature, pull the CABIN HEAT knob out until the desired temperature is attained. Additional heat is available by pulling the knob out farther; maximum heat is available with the CABIN HEAT knob pulled out and the CABIN AIR knob pushed full in.

Front cabin heat and ventilating air is supplied by outlet holes spaced across a cabin manifold just forward of the pilot's and copilot's feet. Rear cabin heat and air is supplied by two ducts from the manifold, one extending down each side of the cabin to an outlet at the front door post at floor level. Windshield defrost air is also supplied by a duct leading from the cabin manifold to an outlet on top of the anti-glare shield. Defrost air flow is controlled by a rotary type knob labeled DEFROST.

Separate adjustable ventilators supply additional ventilation air to the

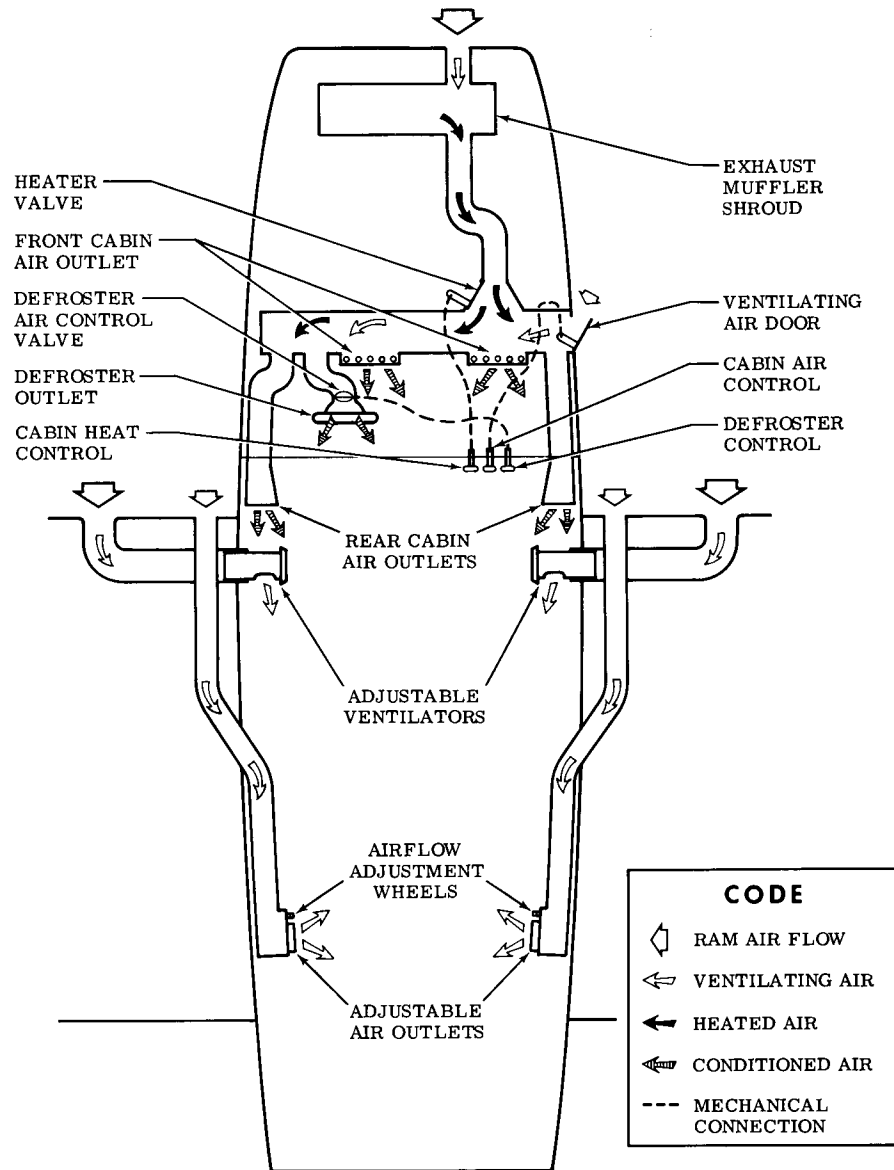

Figure 7-8. Cabin Heating, Ventilating, and Defrosting System

cabin. One near each upper corner of the windshield supplies air for the pilot and copilot, and two ventilators are available for the rear cabin area to supply air to the rear seat passengers. Each rear ventilator outlet can be adjusted in any desired direction by moving the entire outlet to direct the airflow up or down, and by moving a tab protruding from the center of the outlet left or right to obtain left or right airflow. Ventilation airflow may be closed off completely, or partially closed according to the amount of airflow desired, by rotating an adjustment wheel adjacent to the outlet.

## **PITOT-STATIC SYSTEM AND INSTRUMENTS**

The pitot-static system supplies ram air pressure to the airspeed indicator and static pressure to the airspeed indicator, rate-of-climb indicator and altimeter. The system is composed of either an unheated or heated pitot tube mounted on the lower surface of the left wing, two external static ports on the lower left and right sides of the fuselage, and the associated plumbing necessary to connect the instruments to the sources.

The heated pitot system consists of a heating element in the pitot tube, a rocker-type switch labeled PITOT HEAT and a 15-amp circuit breaker on the switch and control panel, and associated wiring. When the pitot heat switch is turned on, the element in the pitot tube is heated electrically to maintain proper operation in possible icing conditions. Pitot heat should be used only as required.

A static pressure alternate source valve may be installed adjacent to the parking brake for use when the external static source is malfunctioning. This valve supplies static pressure from inside the cabin instead of the external static ports.

If erroneous instrument readings are suspected due to water or ice in the pressure line going to the standard external static pressure source, the alternate static source valve should be pulled on.

Pressures within the cabin will vary with open cabin ventilators and windows. Refer to Sections 3 and 5 for the effect of varying cabin pressures on airspeed and altimeter readings.

### **AIRPEED INDICATOR**

The airspeed indicator is calibrated in knots and miles per hour. Limitation and range markings include the white arc (48 to 95 knots), green arc (53 to 141 knots), yellow arc (141 to 176 knots), and a red line (176 knots).

If a true airspeed indicator is installed, it is equipped with a rotatable

ring which works in conjunction with the airspeed indicator dial in a manner similar to the operation of a flight computer. To operate the indicator, first rotate the ring until pressure altitude is aligned with outside air temperature in degrees Fahrenheit. Pressure altitude should not be confused with indicated altitude. To obtain pressure altitude, momentarily set the barometric scale on the altimeter to 29.92 and read pressure altitude on the altimeter. Be sure to return the altimeter barometric scale to the original barometric setting after pressure altitude has been obtained. Having set the ring to correct for altitude and temperature, then read the airspeed shown on the rotatable ring by the indicator pointer. For best accuracy, this indication should be corrected to calibrated airspeed by referring to the Airspeed Calibration chart in Section 5. Knowing the calibrated airspeed, read true airspeed on the ring opposite the calibrated airspeed.

#### **RATE-OF-CLIMB INDICATOR**

The rate-of-climb indicator depicts airplane rate of climb or descent in feet per minute. The pointer is actuated by an atmospheric pressure change supplied by the static source.

#### **ALTIMETER**

Airplane altitude is depicted by a barometric type altimeter. A knob near the lower left portion of the indicator provides adjustment of the instrument's barometric scale to the proper barometric pressure reading.

### **VACUUM SYSTEM AND INSTRUMENTS**

An engine-driven vacuum system (see figure 7-9) provides the suction necessary to operate the attitude indicator and directional indicator. The system consists of a vacuum pump mounted on the engine, a vacuum relief valve and vacuum system air filter on the aft side of the firewall below the instrument panel, and instruments (including a suction gage) on the left side of the instrument panel.

#### **ATTITUDE INDICATOR**

The attitude indicator gives a visual indication of flight attitude. Bank attitude is presented by a pointer at the top of the indicator relative to the bank scale which is marked in increments of 10°, 20°, 30°, 60°, and 90° either side of the center mark. Pitch attitude is presented by a miniature airplane in relation to the horizon bar. A knob at the bottom of the instrument is provided for in-flight adjustment of the miniature airplane to the horizon bar for a more accurate flight attitude indication.

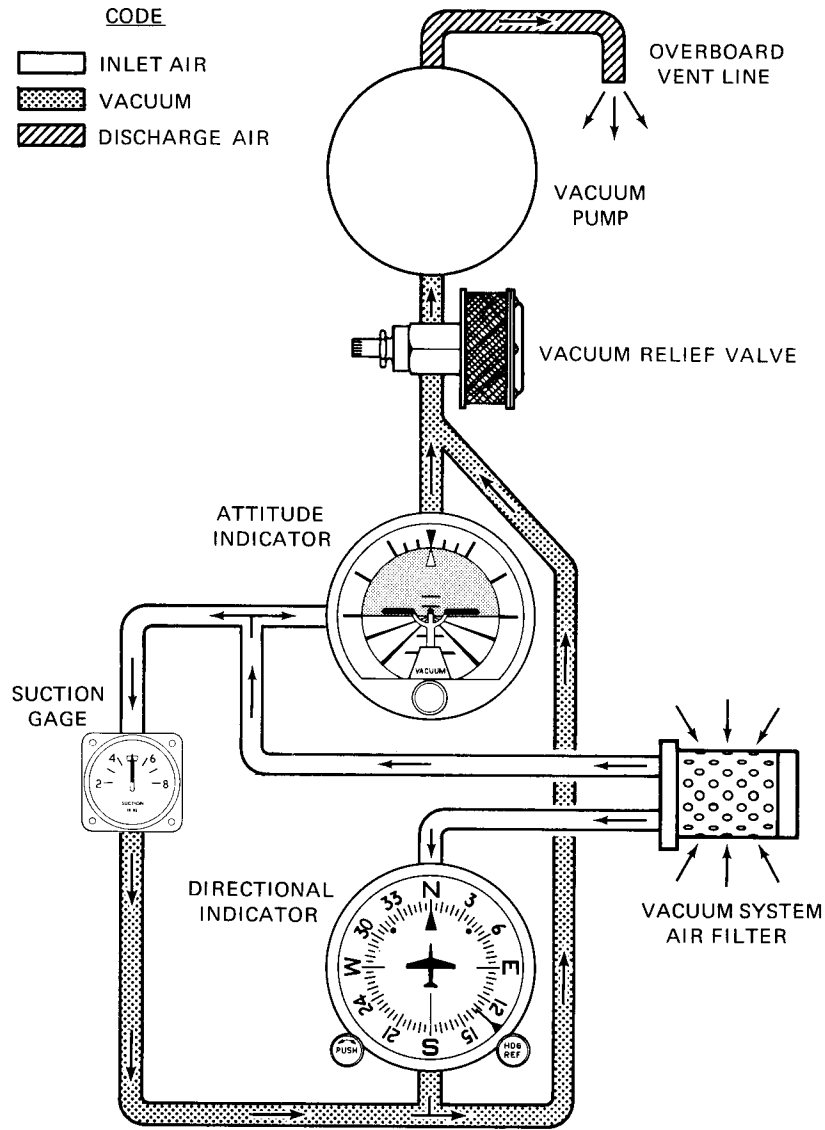

Figure 7-9. Vacuum System



## **DIRECTIONAL INDICATOR**

A directional indicator displays airplane heading on a compass card in relation to a fixed simulated airplane image and index. The directional indicator will precess slightly over a period of time. Therefore, the compass card should be set in accordance with the magnetic compass just prior to takeoff, and occasionally re-adjusted on extended flights. A knob on the lower left edge of the instrument is used to adjust the compass card to correct for any precession.

## **SUCTION GAGE**

The suction gage is located on the left side of the instrument panel and indicates, in inches of mercury, the amount of suction available for operation of the attitude indicator and directional indicator. The desired suction range is 4.6 to 5.4 inches of mercury. A suction reading below this range may indicate a system malfunction or improper adjustment, and in this case, the indicators should not be considered reliable.

## **STALL WARNING SYSTEM**

The airplane is equipped with a vane-type stall warning unit, in the leading edge of the left wing, which is electrically connected to a stall warning horn under the map compartment. A 5-amp circuit breaker protects the stall warning system. The vane in the wing senses the change in airflow over the wing, and operates the warning horn at airspeeds between 5 and 10 knots above the stall in all configurations.

If the airplane has a heated stall warning system, the vane and sensor unit in the wing leading edge is equipped with a heating element. The heated part of the system is operated by the PITOT HEAT switch, and is protected by the PITOT HEAT circuit breaker.

The stall warning system should be checked during the pre-flight inspection by momentarily turning on the master switch and actuating the vane in the wing. The system is operational if the warning horn sounds as the vane is pushed upward.

## **AVIONICS SUPPORT EQUIPMENT**

The airplane may, at the owner's discretion, be equipped with various types of avionics support equipment such as an audio control panel, microphone-headset, and static dischargers. The following paragraphs discuss these items.

**AUTOMATIC AUDIO SELECTION**

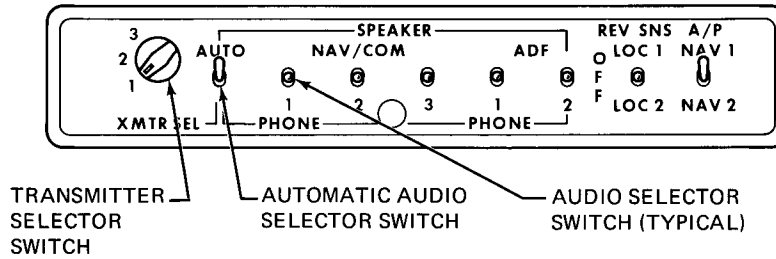

As illustrated, the number 1 transmitter is selected, the AUTO selector switch is in the SPEAKER position, and the NAV/COM 1, 2 and 3 and ADF 1 and 2 audio selector switches are in the OFF position. With the switches set as shown, the pilot will transmit on the number 1 transmitter and hear the number 1 NAV/COM receiver through the airplane speaker.

**INDIVIDUAL AUDIO SELECTION**

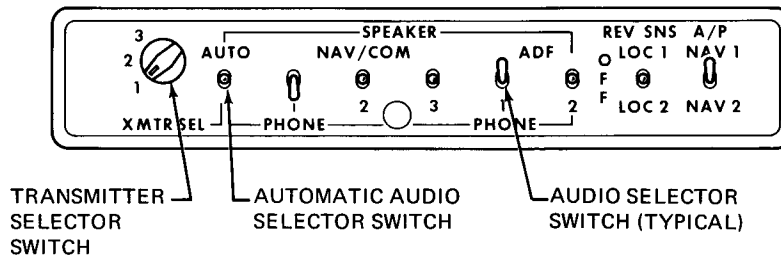

As illustrated, the number 1 transmitter is selected, the AUTO selector switch is in the OFF position, the number 1 NAV/COM receiver is in the PHONE position, and the number 1 ADF is in the SPEAKER position. With the switches set as shown, the pilot will transmit on the number 1 transmitter and hear the number 1 NAV/COM receiver on a headset; while the passengers are listening to the ADF audio through the airplane speaker. If another audio selector switch is placed in either the PHONE or SPEAKER position, it will be heard simultaneously with either the number 1 NAV/COM or number 1 ADF respectively.

Figure 7-10. Audio Control Panel (Sheet 1 of 2)

**BACK - COURSE AND AUTOPILOT RECEIVER SWITCHES**

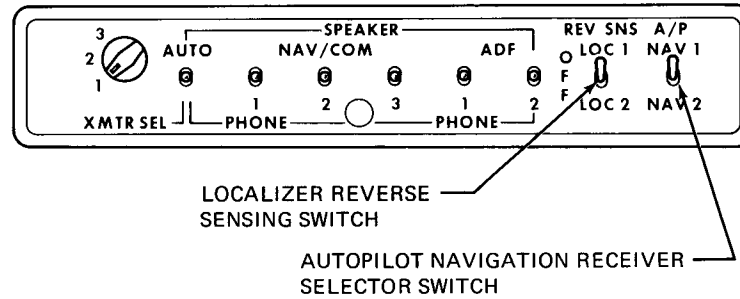

As illustrated, the Course Deviation Indicator associated with the number 1 Navigation Receiver will indicate normally in localizer operation during a back-course approach, and the autopilot will be operating from number 1 Navigation Receiver. BC light on number 1 CDI will be illuminated, warning pilot that CDI indications have been reversed for back course operations. Glide slope indications are unaffected regardless of switch position.

Figure 7-10. Audio Control Panel (Sheet 2 of 2)

**AUDIO CONTROL PANEL**

Operation of radio equipment is covered in Section 9 of this handbook. When one or more radios are installed, a transmitter/audio switching system is provided (see figure 7-10). The operation of this switching system is described in the following paragraphs.

**TRANSMITTER SELECTOR SWITCH**

A rotary type transmitter selector switch, labeled XMTR SEL, is provided to connect the microphone to the transmitter the pilot desires to use. To select a transmitter, rotate the switch to the number corresponding to that transmitter. The numbers 1, 2 and 3 on the left side of the switch correspond to the top, second and third transceivers in the avionics stack.

An audio amplifier is required for speaker operation, and is automatically selected, along with the transmitter, by the transmitter selector switch. As an example, if the number 1 transmitter is selected, the audio amplifier in the associated NAV/COM receiver is also selected, and functions as the amplifier for ALL speaker audio. In the event the audio am-

plifier in use fails, as evidenced by loss of all speaker audio, select another transmitter. This should re-establish speaker audio. Headset audio is not affected by audio amplifier operation.

#### **AUTOMATIC AUDIO SELECTOR SWITCH**

A toggle switch, labeled AUTO, can be used to automatically match the appropriate NAV/COM receiver audio to the transmitter being selected. To utilize this automatic feature, leave all NAV/COM receiver switches in the OFF (center) position, and place the AUTO selector switch in either the SPEAKER or PHONE position, as desired. Once the AUTO selector switch is positioned, the pilot may then select any transmitter and its associated NAV/COM receiver audio simultaneously with the transmitter selector switch. If automatic audio selection is not desired, the AUTO selector switch should be placed in the OFF (center) position.

#### **AUDIO SELECTOR SWITCHES**

The audio selector switches, labeled NAV/COM 1, 2 and 3 and ADF 1 and 2, allow the pilot to initially pre-tune all NAV/COM and ADF receivers, and then individually select and listen to any receiver or combination of receivers. To listen to a specific receiver, first check that the AUTO selector switch is in the OFF (center) position, then place the audio selector switch corresponding to that receiver in either the SPEAKER (up) or PHONE (down) position. To turn off the audio of the selected receiver, place that switch in the OFF (center) position. If desired, the audio selector switches can be positioned to permit the pilot to listen to one receiver on a headset while the passengers listen to another receiver on the airplane speaker.

The ADF 1 and 2 switches may be used anytime ADF audio is desired. If the pilot wants only ADF audio, for station identification or other reasons, the AUTO selector switch (if in use) and all other audio selector switches should be in the OFF position. If simultaneous ADF and NAV/COM audio is acceptable to the pilot, no change in the existing switch positions is required. Place the ADF 1 or 2 switch in either the SPEAKER or PHONE position and adjust radio volume as desired.

#### **NOTE**

If the NAV/COM audio selector switch corresponding to the selected transmitter is in the PHONE position with the AUTO selector switch in the SPEAKER position, all audio selector switches placed in the PHONE position will automatically be connected to both the airplane speaker and any headsets in use.

### LOCALIZER REVERSE SENSING (BACK-COURSE) SWITCH

When installed, the optional localizer reverse sensing switch, labeled REV SNS LOC 1, LOC 2, allows the pilot to reverse normal localizer needle indications on the selected Course Deviation Indicator (CDI) when the selected navigation receiver is set to a localizer frequency. This switch is provided for back-course operation only and will allow the pilot to fly a front course outbound or back course inbound. When the REV SNS switch is moved from the center OFF position to either LOC 1 or LOC 2 position, an amber light located within the CDI, labeled BC, will illuminate to warn the pilot that the course indicator needle is reversed.

#### **CAUTION**

When an autopilot is installed with this switch, selection of LOC 1 or LOC 2 will always reverse localizer signals to the autopilot computer for back course operation. Glide slope indications are not affected.

### AUTOPILOT NAVIGATION RECEIVER SELECTOR SWITCH

An autopilot navigation receiver selector switch, labeled A/P NAV 1, NAV 2, is installed when a Cessna 200A or 300A Autopilot system is installed. The switch allows the pilot to select the desired navigation receiver for autopilot operation. Since the switch does not have a center OFF position, placing the switch in either position will automatically select the associated navigation information for the autopilot.

### MICROPHONE-HEADSET

The microphone-headset combination consists of the microphone and headset combined in a single unit and a microphone keying switch located on the left side of the pilot's control wheel. The microphone-headset permits the pilot to conduct radio communications without interrupting other control operations to handle a hand-held microphone. Also, passengers need not listen to all communications. The microphone and headset jacks are located near the lower left corner of the instrument panel.

### STATIC DISCHARGERS

If frequent IFR flights are planned, installation of wick-type static dischargers is recommended to improve radio communications during flight through dust or various forms of precipitation (rain, freezing rain, snow or ice crystals). Under these conditions, the build-up and discharge of

static electricity from the trailing edges of the wings, rudder, elevator, propeller tips and radio antennas can result in loss of usable radio signals on all communications and navigation radio equipment. Usually the ADF is first to be affected and VHF communication equipment is the last to be affected.

Installation of static dischargers reduces interference from precipitation static, but it is possible to encounter severe precipitation static conditions which might cause the loss of radio signals, even with static dischargers installed. Whenever possible, avoid known severe precipitation areas to prevent loss of dependable radio signals. If avoidance is impractical, minimize airspeed and anticipate temporary loss of radio signals while in these areas.

# SECTION 8

## AIRPLANE HANDLING, SERVICE & MAINTENANCE

### TABLE OF CONTENTS

	Page
Introduction . . . . .	8-3
Identification Plate . . . . .	8-3
Owner Follow-Up System . . . . .	8-3
Publications . . . . .	8-3
Airplane File . . . . .	8-4
Airplane Inspection Periods . . . . .	8-5
FAA Required Inspections . . . . .	8-5
Cessna Progressive Care . . . . .	8-6
Cessna Customer Care Program . . . . .	8-6
Pilot Conducted Preventive Maintenance . . . . .	8-7
Alterations or Repairs . . . . .	8-7
Ground Handling . . . . .	8-7
Towing . . . . .	8-7
Parking . . . . .	8-7
Tie-Down . . . . .	8-8
Jacking . . . . .	8-8
Leveling . . . . .	8-9
Flyable Storage . . . . .	8-9
Servicing . . . . .	8-10
Engine Oil . . . . .	8-10
Fuel . . . . .	8-11
Landing Gear . . . . .	8-11
Oxygen . . . . .	8-12
Cleaning and Care . . . . .	8-12
Windshield-Windows . . . . .	8-12
Painted Surfaces . . . . .	8-12
Propeller Care . . . . .	8-13
Engine Care . . . . .	8-13
Interior Care . . . . .	8-14





## INTRODUCTION

This section contains factory-recommended procedures for proper ground handling and routine care and servicing of your Cessna. It also identifies certain inspection and maintenance requirements which must be followed if your airplane is to retain that new-plane performance and dependability. It is wise to follow a planned schedule of lubrication and preventive maintenance based on climatic and flying conditions encountered in your locality.

Keep in touch with your Cessna Dealer and take advantage of his knowledge and experience. He knows your airplane and how to maintain it. He will remind you when lubrications and oil changes are necessary, and about other seasonal and periodic services.

## IDENTIFICATION PLATE

All correspondence regarding your airplane should include the SERIAL NUMBER. The Serial Number, Model Number, Production Certificate Number (PC) and Type Certificate Number (TC) can be found on the Identification Plate, located on the left forward doorpost. Located adjacent to the Identification Plate is a Finish and Trim Plate which contains a code describing the interior color scheme and exterior paint combination of the airplane. The code may be used in conjunction with an applicable Parts Catalog if finish and trim information is needed.

## OWNER FOLLOW-UP SYSTEM

Your Cessna Dealer has an Owner Follow-Up System to notify you when he receives information that applies to your Cessna. In addition, if you wish, you may choose to receive similar notification, in the form of Service Letters, directly from the Cessna Customer Services Department. A subscription form is supplied in your Customer Care Program book for your use, should you choose to request this service. Your Cessna Dealer will be glad to supply you with details concerning these follow-up programs, and stands ready, through his Service Department, to supply you with fast, efficient, low-cost service.

## PUBLICATIONS

Various publications and flight operation aids are furnished in the

airplane when delivered from the factory. These items are listed below.

- CUSTOMER CARE PROGRAM BOOK
- PILOT'S OPERATING HANDBOOK OR SUPPLEMENTS FOR YOUR AIRPLANE AVIONICS AND AUTOPILOT
- POWER COMPUTER
- SALES AND SERVICE DEALER DIRECTORY
- DO'S AND DON'TS ENGINE BOOKLET

The following additional publications, plus many other supplies that are applicable to your airplane, are available from your Cessna Dealer.

- SERVICE MANUALS AND PARTS CATALOGS FOR YOUR AIRPLANE ENGINE AND ACCESSORIES AVIONICS AND AUTOPILOT

Your Cessna Dealer has a Customer Care Supplies Catalog covering all available items, many of which he keeps on hand. He will be happy to place an order for any item which is not in stock.

## **AIRPLANE FILE**

There are miscellaneous data, information and licenses that are a part of the airplane file. The following is a checklist for that file. In addition, a periodic check should be made of the latest Federal Aviation Regulations to ensure that all data requirements are met.

A. To be displayed in the airplane at all times:

- (1) Aircraft Airworthiness Certificate (FAA Form 8100-2).
- (2) Aircraft Registration Certificate (FAA Form 8050-3).
- (3) Aircraft Radio Station License, if transmitter installed (FCC Form 556).

B. To be carried in the airplane at all times:

- (1) Weight and Balance, and associated papers (latest copy of the Repair and Alteration Form, FAA Form 337, if applicable).
- (2) Equipment List.

C. To be made available upon request:

- (1) Airplane Log Book.
- (2) Engine Log Book.

Most of the items listed are required by the United States Federal Aviation Regulations. Since the Regulations of other nations may require other documents and data, owners of airplanes not registered in the United States should check with their own aviation officials to determine their individual requirements.

Cessna recommends that these items, plus the Pilot's Operating Handbook, Power Computer, Customer Care Program book and Customer Care Card, be carried in the airplane at all times.

## **AIRPLANE INSPECTION PERIODS**

### **FAA REQUIRED INSPECTIONS**

As required by Federal Aviation Regulations, all civil aircraft of U. S. registry must undergo a complete inspection (annual) each twelve calendar months. In addition to the required ANNUAL inspection, aircraft operated commercially (for hire) must have a complete inspection every 100 hours of operation.

The FAA may require other inspections by the issuance of airworthiness directives applicable to the airplane, engine, propeller and components. It is the responsibility of the owner/operator to ensure compliance with all applicable airworthiness directives and, when the inspections are repetitive, to take appropriate steps to prevent inadvertent noncompliance.

In lieu of the 100 HOUR and ANNUAL inspection requirements, an airplane may be inspected in accordance with a progressive inspection schedule, which allows the work load to be divided into smaller operations that can be accomplished in shorter time periods.

The CESSNA PROGRESSIVE CARE PROGRAM has been developed to provide a modern progressive inspection schedule that satisfies the complete airplane inspection requirements of both the 100 HOUR and ANNUAL inspections as applicable to Cessna airplanes. The program assists the owner in his responsibility to comply with all FAA inspection requirements, while ensuring timely replacement of life-limited parts and adherence to factory-recommended inspection intervals and maintenance procedures.

### **CESSNA PROGRESSIVE CARE**

The Cessna Progressive Care Program has been designed to help you realize maximum utilization of your airplane at a minimum cost and down-time. Under this program, your airplane is inspected and maintained in four operations at 50-hour intervals during a 200-hour period. The operations are recycled each 200 hours and are recorded in a specially provided Aircraft Inspection Log as each operation is conducted.

The Cessna Aircraft Company recommends Progressive Care for airplanes that are being flown 200 hours or more per year, and the 100-hour inspection for all other airplanes. The procedures for the Progressive Care Program and the 100-hour inspection have been carefully worked out by the factory and are followed by the Cessna Dealer Organization. The complete familiarity of Cessna Dealers with Cessna equipment and factory-approved procedures provides the highest level of service possible at lower cost to Cessna owners.

Regardless of the inspection method selected by the owner, he should keep in mind that FAR Part 43 and FAR Part 91 establishes the requirement that properly certified agencies or personnel accomplish all required FAA inspections and most of the manufacturer recommended inspections.

### **CESSNA CUSTOMER CARE PROGRAM**

Specific benefits and provisions of the CESSNA WARRANTY plus other important benefits for you are contained in your CUSTOMER CARE PROGRAM book supplied with your airplane. You will want to thoroughly review your Customer Care Program book and keep it in your airplane at all times.

Coupons attached to the Program book entitle you to an initial inspection and either a Progressive Care Operation No. 1 or the first 100-hour inspection within the first 6 months of ownership at no charge to you. If you take delivery from your Dealer, the initial inspection will have been performed before delivery of the airplane to you. If you pick up your airplane at the factory, plan to take it to your Dealer reasonably soon after you take delivery, so the initial inspection may be performed allowing the Dealer to make any minor adjustments which may be necessary.

You will also want to return to your Dealer either at 50 hours for your first Progressive Care Operation, or at 100 hours for your first 100-hour inspection depending on which program you choose to establish for your airplane. While these important inspections will be performed for you by any Cessna Dealer, in most cases you will prefer to have the Dealer from whom you purchased the airplane accomplish this work.

## PILOT CONDUCTED PREVENTIVE MAINTENANCE

A certified pilot who owns or operates an airplane not used as an air carrier is authorized by FAR Part 43 to perform limited maintenance on his airplane. Refer to FAR Part 43 for a list of the specific maintenance operations which are allowed.

### NOTE

Pilots operating airplanes of other than U.S. registry should refer to the regulations of the country of certification for information on preventive maintenance that may be performed by pilots.

A Service Manual should be obtained prior to performing any preventive maintenance to ensure that proper procedures are followed. Your Cessna Dealer should be contacted for further information or for required maintenance which must be accomplished by appropriately licensed personnel.

## ALTERATIONS OR REPAIRS

It is essential that the FAA be contacted prior to any alterations on the airplane to ensure that airworthiness of the airplane is not violated. Alterations or repairs to the airplane must be accomplished by licensed personnel.

## GROUND HANDLING

### TOWING

The airplane is most easily and safely maneuvered by hand with the tow-bar attached to the nose wheel. When towing with a vehicle, do not exceed the nose gear turning angle of 29° either side of center, or damage to the gear will result. If the airplane is towed or pushed over a rough surface during hangaring, watch that the normal cushioning action of the nose strut does not cause excessive vertical movement of the tail and the resulting contact with low hangar doors or structure. A flat nose tire or deflated strut will also increase tail height.

### PARKING

When parking the airplane, head into the wind and set the parking brakes. Do not set the parking brakes during cold weather when accumulated moisture may freeze the brakes, or when the brakes are overheated.

Close the cowl flaps, install the control wheel lock and chock the wheels. In severe weather and high wind conditions, tie the airplane down as outlined in the following paragraph.

### **TIE-DOWN**

Proper tie-down procedure is the best precaution against damage to the parked airplane by gusty or strong winds. To tie-down the airplane securely, proceed as follows:

- (1) Set the parking brake and install the control wheel lock.
- (2) Install a surface control lock over the fin and rudder.
- (3) Tie sufficiently strong ropes or chains (700 pounds tensile strength) to the wing and tail tie-down fittings and secure each rope to a ramp tie-down.
- (4) Tie a rope (no chains or cables) to the nose gear torque link and secure to a ramp tie-down.
- (5) Install a pitot tube cover.

### **JACKING**

When a requirement exists to jack the entire airplane off the ground, or when wing jack points are used in the jacking operation, refer to the Service Manual for specific procedures and equipment required.

Individual main gear may be jacked by using the jack pad which is incorporated in the main landing gear strut step assembly. When using the individual gear strut jack pad, flexibility of the gear strut will cause the main wheel to slide inboard as the wheel is raised, tilting the jack. The jack must then be lowered for a second jacking operation. Do not jack both main wheels simultaneously using the individual main gear jack pads.

If nose gear maintenance is required, the nose wheel may be raised off the ground by pressing down on a tailcone bulkhead, just forward of the horizontal stabilizer, and allowing the tail to rest on the tail tie-down ring.

### **NOTE**

Do not apply pressure on the elevator or outboard stabilizer surfaces. When pushing on the tailcone, always apply pressure at a bulkhead to avoid buckling the skin.

To assist in raising and holding the nose wheel off the ground, weight down the tail by placing sand-bags, or suitable weights, on each side of the horizontal stabilizer, next to the fuselage. If ground anchors are

available, the tail should be securely tied down.

**NOTE**

Ensure that the nose will be held off the ground under all conditions by means of suitable stands or supports under weight supporting bulkheads near the nose of the airplane.

**LEVELING**

The reference point for leveling the airplane longitudinally is the top of the tailcone between the rear window and the vertical fin. Deflate the nose tire and/or lower or raise the nose strut to properly center the bubble in the level. Corresponding points on both upper door sills may be used to level the airplane laterally.

**FLYABLE STORAGE**

Airplanes placed in non-operational storage for a maximum of 30 days or those which receive only intermittent operational use for the first 25 hours are considered in flyable storage status. Every seventh day during these periods, the propeller should be rotated by hand through five revolutions. This action "limbers" the oil and prevents any accumulation of corrosion on engine cylinder walls.

**WARNING**

For maximum safety, check that the ignition switch is OFF, the throttle is closed, the mixture control is in the idle cut-off position, and the airplane is secured before rotating the propeller by hand. Do not stand within the arc of the propeller blades while turning the propeller.

After 30 days, the airplane should be flown for 30 minutes or a ground runup should be made just long enough to produce an oil temperature within the lower green arc range. Excessive ground runup should be avoided.

Engine runup also helps to eliminate excessive accumulations of water in the fuel system and other air spaces in the engine. Keep fuel tanks full to minimize condensation in the tanks. Keep the battery fully charged to prevent the electrolyte from freezing in cold weather. If the airplane is to be stored temporarily, or indefinitely, refer to the Service Manual for proper storage procedures.

## SERVICING

In addition to the PREFLIGHT INSPECTION covered in Section 4, COMPLETE servicing, inspection, and test requirements for your airplane are detailed in the Service Manual. The Service Manual outlines all items which require attention at 50, 100, and 200 hour intervals plus those items which require servicing, inspection, and/or testing at special intervals.

Since Cessna Dealers conduct all service, inspection, and test procedures in accordance with applicable Service Manuals, it is recommended that you contact your Cessna Dealer concerning these requirements and begin scheduling your airplane for service at the recommended intervals.

Cessna Progressive Care ensures that these requirements are accomplished at the required intervals to comply with the 100-hour or ANNUAL inspection as previously covered.

Depending on various flight operations, your local Government Aviation Agency may require additional service, inspections, or tests. For these regulatory requirements, owners should check with local aviation officials where the airplane is being operated.

For quick and ready reference, quantities, materials, and specifications for frequently used service items are as follows.

### ENGINE OIL

GRADE -- Aviation Grade SAE 50 Above 4°C (40°F).

Aviation Grade SAE 10W30 or SAE 30 Below 4°C (40°F).

Multi-viscosity oil with a range of SAE 10W30 is recommended for improved starting in cold weather. Ashless dispersant oil, conforming to Continental Motors Specification MHS-24A, must be used.

### NOTE

Your Cessna was delivered from the factory with a corrosion preventive aircraft engine oil. If oil must be added during the first 25 hours, use only aviation grade straight mineral oil conforming to Specification No. MIL-L-6082.

CAPACITY OF ENGINE SUMP -- 12 Quarts.

Do not operate on less than 9 quarts. To minimize loss of oil through breather, fill to 10 quart level for normal flights of less than 3 hours. For extended flight, fill to 12 quarts. These quantities refer to oil



dipstick level readings. During oil and oil filter changes, one additional quart is required when the filter element is changed.

**OIL AND OIL FILTER CHANGE --**

After the first 25 hours of operation, drain engine oil sump and clean the oil pressure screen. If an oil filter is installed, change the filter element at this time. Refill sump with straight mineral oil and use until a total of 50 hours has accumulated or oil consumption has stabilized; then change to dispersant oil. On aircraft not equipped with an oil filter, drain the engine oil sump and clean the oil pressure screen each 50 hours thereafter. On aircraft which have an oil filter, the oil change interval may be extended to 100-hour intervals, providing the oil filter element is changed at 50-hour intervals. Change engine oil at least every 6 months even though less than the recommended hours have accumulated. Reduce intervals for prolonged operation in dusty areas, cold climates, or when short flights and long idle periods result in sludging conditions.

**FUEL**

GRADE (AND COLOR) -- 80/87 Minimum Grade Aviation Fuel (red).  
Alternate fuels which are also approved are:  
100/130 Low Lead AVGAS (blue). (Maximum lead content of 2 cc per gallon.)  
100/130 Aviation Grade Fuel (green). (Maximum lead content of 4.6 cc per gallon.)

**NOTE**

When substituting a higher octane fuel, low lead AVGAS 100 should be used whenever possible since it will result in less lead contamination of the engine.

CAPACITY EACH STANDARD TANK -- 30.5 Gallons.  
CAPACITY EACH LONG RANGE TANK -- 40.0 Gallons.

**NOTE**

To ensure maximum fuel capacity during refueling, place the fuel selector valve handle in either LEFT or RIGHT position to prevent cross-feeding.

**LANDING GEAR**

NOSE WHEEL TIRE PRESSURE -- 49 PSI on 5.00-5, 6-Ply Rated Tire.  
MAIN WHEEL TIRE PRESSURE -- 42 PSI on 6.00-6, 6-Ply Rated Tires.  
NOSE GEAR SHOCK STRUT --  
Keep filled with MIL-H-5606 hydraulic fluid and inflated with air to 55-60 PSI.

## OXYGEN

AVIATOR'S BREATHING OXYGEN -- Spec No. MIL-O-27210.  
MAXIMUM PRESSURE (cylinder temperature stabilized after filling) --  
1800 PSI at 21°C (70°F). Refer to Oxygen Supplement (Section 9)  
for filling pressures.

## CLEANING AND CARE

### WINDSHIELD-WINDOWS

The plastic windshield and windows should be cleaned with an aircraft windshield cleaner. Apply the cleaner sparingly with soft cloths, and rub with moderate pressure until all dirt, oil scum and bug stains are removed. Allow the cleaner to dry, then wipe it off with soft flannel cloths.

If a windshield cleaner is not available, the plastic can be cleaned with soft cloths moistened with Stoddard solvent to remove oil and grease.

#### NOTE

Never use gasoline, benzine, alcohol, acetone, carbon tetrachloride, fire extinguisher or anti-ice fluid, lacquer thinner or glass cleaner to clean the plastic. These materials will attack the plastic and may cause it to craze.

Follow by carefully washing with a mild detergent and plenty of water. Rinse thoroughly, then dry with a clean moist chamois. Do not rub the plastic with a dry cloth since this builds up an electrostatic charge which attracts dust. Waxing with a good commercial wax will finish the cleaning job. A thin, even coat of wax, polished out by hand with clean soft flannel cloths, will fill in minor scratches and help prevent further scratching.

Do not use a canvas cover on the windshield unless freezing rain or sleet is anticipated since the cover may scratch the plastic surface.

### PAINTED SURFACES

The painted exterior surfaces of your new Cessna have a durable, long lasting finish and, under normal conditions, require no polishing or buffing. Approximately 15 days are required for the paint to cure completely; in most cases, the curing period will have been completed prior to delivery of the airplane. In the event that polishing or buffing is required within the curing period, it is recommended that the work be done

by someone experienced in handling uncured paint. Any Cessna Dealer can accomplish this work.

Generally, the painted surfaces can be kept bright by washing with water and mild soap, followed by a rinse with water and drying with cloths or a chamois. Harsh or abrasive soaps or detergents which cause corrosion or scratches should never be used. Remove stubborn oil and grease with a cloth moistened with Stoddard solvent.

Waxing is unnecessary to keep the painted surfaces bright. However, if desired, the airplane may be waxed with a good automotive wax. A heavier coating of wax on the leading edges of the wings and tail and on the engine nose cap and propeller spinner will help reduce the abrasion encountered in these areas.

When the airplane is parked outside in cold climates and it is necessary to remove ice before flight, care should be taken to protect the painted surfaces during ice removal with chemical liquids. A 50-50 solution of isopropyl alcohol and water will satisfactorily remove ice accumulations without damaging the paint. A solution with more than 50% alcohol is harmful and should be avoided. While applying the de-icing solution, keep it away from the windshield and cabin windows since the alcohol will attack the plastic and may cause it to craze.

#### **PROPELLER CARE**

Preflight inspection of propeller blades for nicks, and wiping them occasionally with an oily cloth to clean off grass and bug stains will assure long, trouble-free service. Small nicks on the propeller, particularly near the tips and on the leading edges, should be dressed out as soon as possible since these nicks produce stress concentrations, and if ignored, may result in cracks. Never use an alkaline cleaner on the blades; remove grease and dirt with carbon tetrachloride or Stoddard solvent.

#### **ENGINE CARE**

The engine may be cleaned with Stoddard solvent, or equivalent, then dried thoroughly.

#### **CAUTION**

Particular care should be given to electrical equipment before cleaning. Cleaning fluids should not be allowed to enter magnetos, starter, alternator and the like. Protect these components before saturating the engine

with solvents. All other openings should also be covered before cleaning the engine assembly. Caustic cleaning solutions should be used cautiously and should always be properly neutralized after their use.

### INTERIOR CARE

To remove dust and loose dirt from the upholstery and carpet, clean the interior regularly with a vacuum cleaner.

Blot up any spilled liquid promptly with cleansing tissue or rags. Don't pat the spot; press the blotting material firmly and hold it for several seconds. Continue blotting until no more liquid is taken up. Scrape off sticky materials with a dull knife, then spot-clean the area.

Oily spots may be cleaned with household spot removers, used sparingly. Before using any solvent, read the instructions on the container and test it on an obscure place on the fabric to be cleaned. Never saturate the fabric with a volatile solvent; it may damage the padding and backing materials.

Soiled upholstery and carpet may be cleaned with foam-type detergent, used according to the manufacturer's instructions. To minimize wetting the fabric, keep the foam as dry as possible and remove it with a vacuum cleaner.

If your airplane is equipped with leather seating, cleaning of the seats is accomplished using a soft cloth or sponge dipped in mild soap suds. The soap suds, used sparingly, will remove traces of dirt and grease. The soap should be removed with a clean damp cloth.

The plastic trim, headliner, instrument panel and control knobs need only be wiped off with a damp cloth. Oil and grease on the control wheel and control knobs can be removed with a cloth moistened with Stoddard solvent. Volatile solvents, such as mentioned in paragraphs on care of the windshield, must never be used since they soften and craze the plastic.

# SECTION 9 SUPPLEMENTS (Optional Systems Description & Operating Procedures)

## TABLE OF CONTENTS

Introduction

Supplements:

Emergency Locator Transmitter (ELT) . . . . .	(4 pages)
Electric Elevator Trim System . . . . .	(2 pages)
Oxygen System . . . . .	(6 pages)
Cessna 300 Transceiver (Type RT-524A) . . . . .	(4 pages)
Cessna 300 Nav/Com (Type RT-308C) . . . . .	(4 pages)
Cessna 300 Nav/Com (Type RT-528E-1) . . . . .	(6 pages)
Cessna 300 Nav/Com (Type RT-328T) . . . . .	(6 pages)
Cessna 300 ADF (Type R-546E) . . . . .	(6 pages)
Cessna 300 Transponder (Type RT-359A) and Optional Altitude Encoder (Type EA-401A) . . . . .	(6 pages)
DME (Type 190) . . . . .	(4 pages)
HF Transceiver (Type PT10-A) . . . . .	(4 pages)
SSB HF Transceiver (Type ASB-125) . . . . .	(4 pages)
Cessna 400 ADF (Type R-446A) . . . . .	(6 pages)
Cessna 400 Marker Beacon (Type R-402A) . . . . .	(4 pages)
Cessna 400 Transponder (Type RT-459A) and Optional Altitude Encoder (Type EA-401A) . . . . .	(6 pages)
Cessna 200A Autopilot (Type AF-295B) . . . . .	(6 pages)
Cessna 300A Autopilot (Type AF-395A) . . . . .	(6 pages)

## INTRODUCTION

This section consists of a series of supplements, each covering a single optional system which may be installed in the airplane. Each supplement contains a brief description, and when applicable, operating limitations, emergency and normal procedures, and performance. Other routinely installed items of optional equipment, whose function and operational procedures do not require detailed instructions, are discussed in Section 7.

# SUPPLEMENT

## EMERGENCY LOCATOR TRANSMITTER (ELT)

### SECTION 1 GENERAL

The ELT consists of a self-contained dual-frequency radio transmitter and battery power supply, and is activated by an impact of 5g or more as may be experienced in a crash landing. The ELT emits an omni-directional signal on the international distress frequencies of 121.5 and 243.0 MHz. (Some ELT units in export aircraft transmit only on 121.5 MHz.) General aviation and commercial aircraft, the FAA, and CAP monitor 121.5 MHz, and 243.0 MHz is monitored by the military. Following a crash landing, the ELT will provide line-of-sight transmission up to 100 miles at 10,000 feet. The duration of ELT transmissions is affected by ambient temperature. At temperatures of +21° to +54°C (+70° to +130°F), continuous transmission for 115 hours can be expected; a temperature of -40°C (-40°F) will shorten the duration to 70 hours.

The ELT is readily identified as a bright orange unit mounted behind the baggage compartment wall in the tailcone. To gain access to the unit, remove the baggage compartment wall. The ELT is operated by a control panel at the forward facing end of the unit (see figure 1).

### SECTION 2 LIMITATIONS

There is no change to the airplane limitations when this equipment is installed.

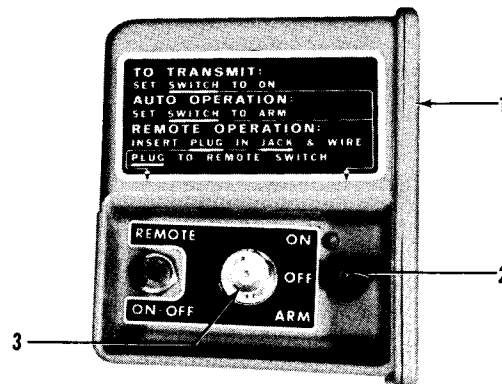

1. COVER - Removable for access to battery.
2. FUNCTION SELECTOR SWITCH (3-position toggle switch):
  - ON - Activates transmitter instantly. Used for test purposes and if "g" switch is inoperative.
  - OFF - Deactivates transmitter. Used during shipping, storage and following rescue.
  - ARM - Activates transmitter only when "g" switch receives 5g or more impact.
3. ANTENNA RECEPTACLE - Connection to antenna mounted on top of the tailcone.

Figure 1. ELT Control Panel

### SECTION 3

## EMERGENCY PROCEDURES

Immediately after a forced landing where emergency assistance is required, the ELT should be utilized as follows.

- (1) ENSURE ELT ACTIVATION: Turn a radio transceiver ON and select 121.5 MHz. If the ELT can be heard transmitting, it was activated by the "g" switch and is functioning properly. If no emergency tone is audible, gain access to the ELT and place the function se-



lector switch in the ON position.

(2) PRIOR TO SIGHTING RESCUE AIRCRAFT: Conserve airplane battery. Do not activate radio transceiver.

(3) AFTER SIGHTING RESCUE AIRCRAFT: Place ELT function selector switch in the OFF position, preventing radio interference. Attempt contact with rescue aircraft with the radio transceiver set to a frequency of 121.5 MHz. If no contact is established, return the function selector switch to ON immediately.

(4) FOLLOWING RESCUE: Place ELT function selector switch in the OFF position, terminating emergency transmissions.

## SECTION 4 NORMAL PROCEDURES

As long as the function selector switch remains in the ARM position, the ELT automatically activates following an impact of 5g or more over a short period of time.

Following a lightning strike, or an exceptionally hard landing, the ELT may activate although no emergency exists. To check your ELT for inadvertent activation, select 121.5 MHz on your radio transceiver and listen for an emergency tone transmission. If the ELT can be heard transmitting, place the function selector switch in the OFF position and the tone should cease. Immediately place the function selector switch in the ARM position to re-set the ELT for normal operation.

## SECTION 5 PERFORMANCE

There is no change to the airplane performance data when this equipment is installed.



# SUPPLEMENT

## ELECTRIC ELEVATOR TRIM SYSTEM

### SECTION 1 GENERAL

The electric elevator trim system provides a simple method of relieving pitch control pressures without interrupting other control operations to adjust the manual elevator trim wheel. The system is controlled by a slide-type trim switch on the top of the left control wheel grip and a disengage switch located on the left side of the control wheel pad. Pushing the trim switch to the forward position, labeled DN, moves the elevator trim tab in the "nose down" direction; conversely, pulling the switch aft to the UP position moves the tab in the "nose up" direction. When the switch is released, it automatically returns to the center off position, and elevator trim tab motion stops. The disengage switch, labeled ELEC TRIM DISENGAGE, removes all electrical power from the system when placed in the DISENGAGE position.

A servo unit (which includes a motor and chain-driven, solenoid-operated clutch) actuates the trim tab to the selected position. When the clutch is not energized (trim switch off) the electric portion of the trim system freewheels so that manual operation is not affected. The electric trim system can be overridden at any time by manually rotating the elevator trim wheel, thus overriding the servo that drives the trim tab.

### SECTION 2 LIMITATIONS

There is no change to the airplane limitations when this trim system is installed.

### **SECTION 3**

#### **EMERGENCY PROCEDURES**

- (1) Elevator Trim Disengage Switch -- DISENGAGE.

**NOTE**

For maximum altitude loss during an electric trim malfunction, refer to placarding on the instrument panel.

- (2) Manual Trim -- AS REQUIRED.

### **SECTION 4**

#### **NORMAL PROCEDURES**

To operate the electric elevator trim system, proceed as follows:

- (1) Master Switch -- ON.
- (2) Elevator Trim Disengage Switch -- ON.
- (3) Trim Switch -- ACTUATE as desired.
- (4) Elevator Trim Position Indicator -- CHECK.

**NOTE**

To check the operation of the disengage switch, actuate the elevator trim switch with the disengage switch in the DISENGAGE position. Observe that the manual trim wheel and indicator do not rotate when the elevator trim switch is activated.

### **SECTION 5**

#### **PERFORMANCE**

There is no change to the airplane performance when this trim system is installed.

# SUPPLEMENT

## OXYGEN SYSTEM (MODEL 182)

### SECTION 1 GENERAL

A four-place oxygen system provides the supplementary oxygen necessary for continuous flight at high altitude. In this system, an oxygen cylinder, located behind the rear baggage compartment wall, supplies the oxygen. Cylinder pressure is reduced to an operating pressure of 70 psi by a pressure regulator attached to the cylinder. A shutoff valve is included as part of the regulator assembly. An oxygen cylinder filler valve is located on the left side of the rear baggage compartment wall. Cylinder pressure is indicated by a pressure gage located in the overhead oxygen console.

Four oxygen outlets are provided; two in the overhead oxygen console and two in the cabin ceiling just above the side windows, one at each of the seating positions. One permanent, microphone-equipped mask is provided for the pilot, and three disposable type masks are provided for the passengers. All masks are the partial-rebreathing type equipped with vinyl plastic hoses and flow indicators.

A remote shutoff valve control, located adjacent to the pilot's oxygen outlet, is used to shut off the supply of oxygen to the system when not in use. The control is mechanically connected to the shutoff valve at the cylinder. With the exception of the shutoff function, the system is completely automatic and requires no manual regulation for change of altitude.

The oxygen cylinder, when fully charged, contains approximately 48 cubic feet of oxygen, under a pressure of 1800 psi at 21°C (70°F). Filling pressures will vary, however, due to the ambient temperature in the filling area, and because of the temperature rise resulting from compression of the oxygen. Because of this, merely filling to 1800 psi will not result in a properly filled cylinder. Fill to the pressures indicated in the table on the following page for ambient temperature.

#### **WARNING**

Oil, grease or other lubricants in contact with oxygen

AMBIENT TEMPERATURE °F	FILLING PRESSURE PSIG	AMBIENT TEMPERATURE °F	FILLING PRESSURE PSIG
0	1600	50	1825
10	1650	60	1875
20	1700	70	1925
30	1725	80	1975
40	1775	90	2000

Figure 1. Oxygen Filling Pressures

create a serious fire hazard, and such contact must be avoided when handling oxygen equipment.

## SECTION 2 LIMITATIONS

There is no change to the airplane limitations when oxygen equipment is installed.

Supplemental oxygen should be used by all occupants when cruising above 10,000 feet. As described in the Cessna booklet "Man At Altitude," it is often advisable to use oxygen at altitudes lower than 10,000 feet under conditions of night flying, fatigue, or periods of physiological or emotional disturbances. Also, the habitual and excessive use of tobacco or alcohol will usually necessitate the use of oxygen at less than 10,000 feet.

### **WARNING**

For safety reasons, no smoking should be allowed in the airplane while oxygen is being used.

The Oxygen Duration Chart (figure 2) should be used in determining the usable duration (in hours) of the oxygen supply in your airplane. The following procedure outlines the method of finding the duration from the chart.

- (1) Note the available oxygen pressure shown on the pressure gage.
- (2) Locate this pressure on the scale on the left side of the chart, then go across the chart horizontally to the right until you intersect the line representing the number of persons making the flight. After

### OXYGEN DURATION CHART (48 CUBIC FEET CAPACITY)

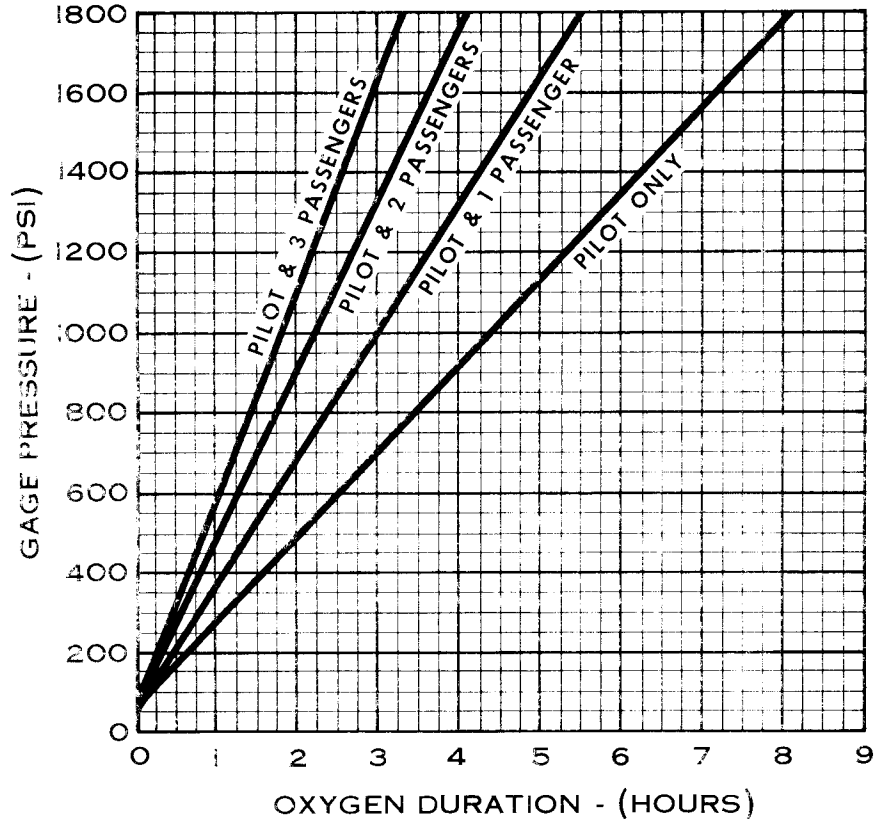

NOTE: This chart is based on a pilot with an orange color-coded oxygen line fitting and passengers with green color-coded line fittings.

Figure 2. Oxygen Duration Chart

intersecting the line, drop down vertically to the bottom of the chart and read the duration in hours given on the scale.

(3) As an example of the above procedure, 1400 psi of pressure will safely sustain the pilot only for nearly 6 hours and 15 minutes. The same pressure will sustain the pilot and three passengers for approximately 2 hours and 30 minutes.

**NOTE**

The Oxygen Duration Chart is based on a standard configuration oxygen system having one orange color-coded hose assembly for the pilot and green color-coded hoses for the passengers. If orange color-coded hoses are provided for pilot and passengers, it will be necessary to compute new oxygen duration figures due to the greater consumption of oxygen with these hoses. This is accomplished by computing the total duration available to the pilot only (from PILOT ONLY line on chart), then dividing this duration by the number of persons (pilot and passengers) using oxygen.

**SECTION 3**  
**EMERGENCY PROCEDURES**

There is no change to the airplane emergency procedures when oxygen equipment is installed.

**SECTION 4**  
**NORMAL PROCEDURES**

Prior to flight, check to be sure that there is an adequate oxygen supply for the trip, by noting the oxygen pressure gage reading, and referring to the Oxygen Duration Chart (figure 2). Also, check that the face masks and hoses are accessible and in good condition.

When ready to use the oxygen system, proceed as follows:

- (1) Mask and Hose -- SELECT. Adjust mask to face and adjust metallic nose strap for snug mask fit.

**NOTE**

The hose provided for the pilot is of a higher flow rate than those for the passengers; it is color-coded with an orange band adjacent to the plug-in fitting. The passenger hoses are color-coded with a green band. If the airplane owner prefers, he may provide higher flow hoses



for all passengers. In any case, it is recommended that the pilot use the larger capacity hose. The pilot's mask is equipped with a microphone to facilitate use of the radio while using oxygen. An adapter cord is furnished with the microphone-equipped mask to mate the mask microphone lead to the auxiliary microphone jack located under the left side of the instrument panel. To connect the oxygen mask microphone, connect the mask lead to the adapter cord and plug the cord into the auxiliary microphone jack. (If an optional microphone-headset combination has been in use, the microphone lead from this equipment is already plugged into the auxiliary microphone jack. It will be necessary to disconnect this lead from the auxiliary microphone jack so that the adapter cord from the oxygen mask microphone can be plugged into the jack.) A switch is incorporated on the left hand control wheel to operate the microphone.

- (2) Delivery Hose -- PLUG INTO OUTLET nearest to the seat you are occupying.

**NOTE**

When the oxygen system is turned on, oxygen will flow continuously at the proper rate of flow for any altitude without any manual adjustments.

- (3) Oxygen Supply Control Knob -- ON.
- (4) Face Mask Hose Flow Indicator -- CHECK. Oxygen is flowing if the indicator is being forced toward the mask.
- (5) Delivery Hose -- UNPLUG from outlet when discontinuing use of oxygen. This automatically stops the flow of oxygen.
- (6) Oxygen Supply Control Knob -- OFF when oxygen is no longer required.

**SECTION 5**  
**PERFORMANCE**

There is no change to the airplane performance when oxygen equipment is installed.



# **SUPPLEMENT**

## **CESSNA 300 TRANSCEIVER**

### **(Type RT-524A)**

#### **SECTION 1**

#### **GENERAL**

The Cessna 300 Transceiver, shown in Figure 1, is a self-contained communications system capable of receiving and transmitting on any one of 360 manually tuned, crystal-controlled channels. The channels are spaced 50 kHz apart and cover a frequency range of 118.00 thru 135.95 MHz.

The 300 Transceiver system consists of a panel-mounted receiver/transmitter, a spike antenna and interconnecting cables. The system utilizes the airplane microphone, headphone and speaker.

All of the required operating controls are mounted on the front panel of the 300 Transceiver except the microphone switch. In addition, when two or more radios are installed, a transmitter selector switch and a speaker-phone selector switch are provided. Each control function is described in Figure 1.

#### **SECTION 2**

#### **LIMITATIONS**

There is no change to the airplane limitations when this avionic equipment is installed.

#### **SECTION 3**

#### **EMERGENCY PROCEDURES**

There is no change to the airplane emergency procedures when this avionic equipment is installed.

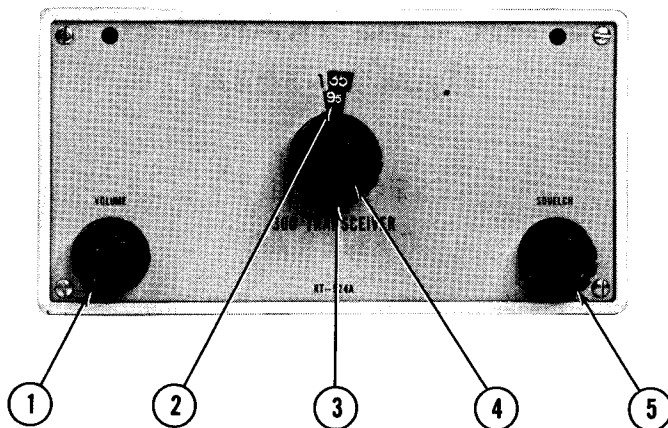

1. **OFF/ON VOLUME CONTROL** - Turns complete set on and controls volume of audio from receiver.
2. **RECEIVER-TRANSMITTER FREQUENCY DIAL.**
3. **RECEIVER-TRANSMITTER FREQUENCY SELECTOR** - Selects receiver-transmitter frequency in 1-MHz steps between 118.00 and 135.00 MHz.
4. **RECEIVER-TRANSMITTER FRACTIONAL FREQUENCY SELECTOR** - Selects receiver-transmitter fractional frequency in 0.05-MHz steps.
5. **SQUELCH CONTROL** - Used to adjust signal threshold necessary to activate receiver audio. Clockwise rotation increases background noise (decreases squelch action); counterclockwise rotation decreases background noise.

Figure 1. Cessna 300 Transceiver Controls

## SECTION 4 NORMAL PROCEDURES

### TO TRANSMIT:

- (1) XMTR SEL Switch -- SELECT transceiver.
- (2) Frequency Selector Knobs -- SELECT operating frequency.
- (3) Radio VOLUME Control -- ON.
- (4) Mike Button -- DEPRESS.

### TO RECEIVE:

- (1) XMTR SEL Switch -- SELECT transceiver.
- (2) SPEAKER/PHONE Switch -- SELECT desired mode.
- (3) Frequency Selector Knobs -- SELECT operating frequency.
- (4) Radio VOLUME Control -- ON and adjust to listening level.
- (5) SQUELCH Control -- ROTATE counterclockwise to decrease background noise.

## SECTION 5 PERFORMANCE

There is no change to the airplane performance when this avionic equipment is installed. However, the installation of an externally mounted antenna or several related external antennas, will result in a minor reduction in cruise performance.



# SUPPLEMENT

## CESSNA 300 NAV/COM

### (VOR Only - Type RT-308C)

#### SECTION 1

#### GENERAL

The Cessna 300 Nav/Com (Type RT-308C), shown in Figure 1, consists of a panel-mounted receiver-transmitter (RT-308C) and a single course deviation indicator (IN-514R or IN-514B). The RT-308C Receiver-Transmitter includes a 360-channel VHF communication receiver-transmitter and a 160-channel VHF navigation receiver, both of which may be operated simultaneously.

The communication receiver-transmitter receives and transmits signals between 118.00 and 135.95 MHz in 50 kHz steps. The navigation receiver receives and interprets VHF omnidirectional range (VOR) signals between 108.00 and 117.95 MHz. Although localizer signals (all odd-tenth frequencies between 108.1 and 111.9 MHz) can also be received, the navigation receiver does not include the circuits required to actuate the course deviation needle. However, the audio portion of the localizer is audible so that flight information, such as that broadcast in certain areas on selected localizer frequencies by the Automatic Terminal Information Service (ATIS), may be heard.

All controls for the Cessna 300 Nav/Com (Type RT-308C), except the omni bearing selector (OBS), are mounted on the front panel of the receiver-transmitter. The course selector and the navigation indicators are included in the course deviation indicator. The communication receiver-transmitter and the navigation receiver are synthesizer-controlled and are tuned automatically when the frequency is selected. In addition, when two or more radios are installed, a transmitter selector switch and a speaker-phone selector switch are provided. Each control function is described in Figure 1.

#### SECTION 2

#### LIMITATIONS

There is no change to the airplane limitations when this avionics equipment is installed.

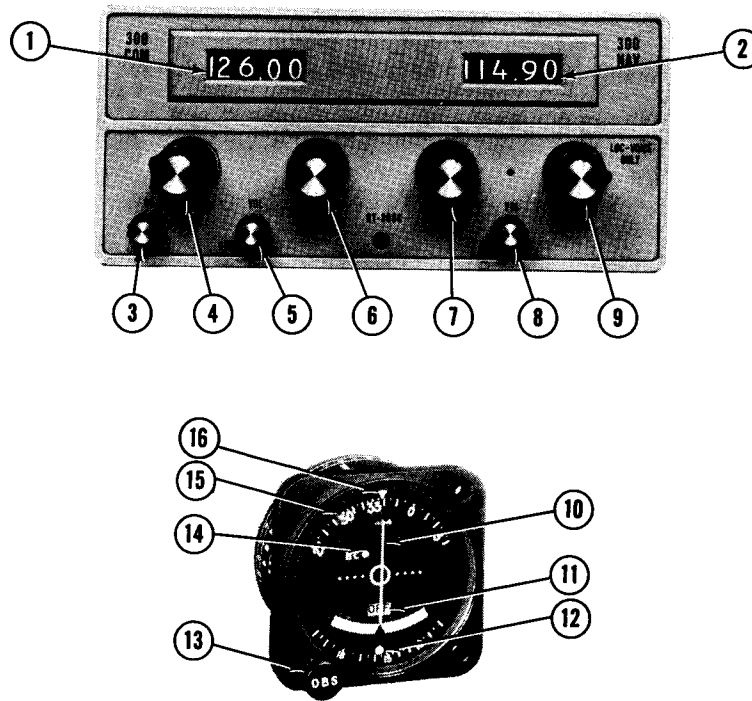

1. RECEIVER-TRANSMITTER FREQUENCY INDICATOR.
2. NAVIGATION RECEIVER FREQUENCY INDICATOR.
3. SQUELCH CONTROL - Used to adjust signal threshold necessary to activate receiver audio. Clockwise rotation increases background noise (decreases squelch action); counterclockwise rotation decreases background noise.
4. COMMUNICATION RECEIVER-TRANSMITTER MEGAHERTZ SELECTOR - Selects communication receiver-transmitter frequency in 1-MHz steps between 118 and 135 MHz.

Figure 1. Cessna 300 Nav/Com (Type RT-308C) - VOR only (Sheet 1 of 2)



5. OFF/ON VOLUME CONTROL - Turns complete set on and controls volume of audio from communication receiver.
6. COMMUNICATION RECEIVER-TRANSMITTER FRACTIONAL MEGAHERTZ SELECTOR - Selects communication receiver-transmitter fractional frequency in 0.05 MHz steps between 0.00 and 0.95 MHz.
7. NAVIGATION RECEIVER MEGAHERTZ SELECTOR - Selects navigation receiver frequency in 1-MHz steps between 108 and 117 MHz.
8. NAVIGATION RECEIVER VOLUME CONTROL - Controls volume of audio from navigation receiver only. Clockwise rotation increases audio level.
9. NAVIGATION RECEIVER FRACTIONAL MEGAHERTZ SELECTOR - Selects navigation receiver frequency in 0.05 MHz steps between 0.00 and 0.95 MHz.
10. COURSE DEVIATION POINTER - Indicates course deviation from selected omni bearing.
11. OFF/TO-FROM (OMNI) INDICATOR - Operates only with VOR signal. "OFF" position (flag) indicates unreliable signal or no signal. When "OFF" position disappears, indicator shows whether selected course is "TO" or "FROM" the station.
12. RECIPROCAL COURSE INDEX - Indicates reciprocal of selected VOR course.
13. OMNI BEARING SELECTOR (OBS) - Selects desired course to or from a VOR station.
14. BACK COURSE (BC) INDICATOR LIGHT (On IN-514B Only) - Not used with this radio.
15. BEARING DIAL.
16. COURSE INDEX - Indicates selected VOR course.

Figure 1. Cessna 300 Nav/Com (Type RT-308C) - VOR only (Sheet 2 of 2)

### **SECTION 3**

## **EMERGENCY PROCEDURES**

There is no change to the airplane emergency procedures when this avionics equipment is installed.

### **SECTION 4**

## **NORMAL PROCEDURES**

#### **TO TRANSMIT:**

- (1) XMTR SEL Switch -- SELECT transceiver.
- (2) COM Frequency Selector Knobs -- SELECT operating frequency.
- (3) OFF/VOL control -- ON.
- (4) Mike Button -- DEPRESS.

#### **TO RECEIVE:**

- (1) XMTR SEL Switch -- SELECT transceiver.
- (2) SPEAKER/PHONE Switch -- SELECT desired mode.
- (3) COM/NAV Frequency Selector Knobs -- SELECT frequency.
- (4) VOL Control -- ADJUST to listening level (OFF/VOL knob must be ON).
- (5) SQ Control -- ROTATE counterclockwise to decrease background noise.

### **SECTION 5**

## **PERFORMANCE**

There is no change to the airplane performance when this avionics equipment is installed. However, the installation of an externally mounted antenna or several related external antennas, will result in a minor reduction in cruise performance.

# SUPPLEMENT

## CESSNA 300 NAV/COM

### (360-Channel - Type RT-528E-1)

#### SECTION 1

#### GENERAL

The Cessna 300 Nav/Com (Type RT-528E-1), shown in Figure 1, consists of a panel-mounted receiver-transmitter and a single- or dual-pointer remote course indicator. The receiver-transmitters include a 360-channel VHF communication receiver-transmitter and a 200-channel VHF navigation receiver.

The communication receiver-transmitter receives and transmits signals between 118.00 and 135.95 MHz in 50 kHz steps. The navigation receiver receives and interprets VOR and localizer signals between 108.00 and 117.95 MHz in 50 kHz steps. The communication receiver-transmitter and the navigation receiver are synthesizer-controlled and are tuned automatically when the frequency is selected.

A DME receiver-transmitter or a glide slope receiver, or both, may be interconnected with the Cessna 300 Nav/Com set for automatic selection of the associated DME or GS frequency. When a VOR frequency is selected on the Nav/Com, the associated VORTAC or VOR-DME station frequency will also be selected automatically; likewise, if a localizer frequency is selected, the associated glide slope frequency will be selected automatically.

All controls of the Cessna 300 Nav/Com, except the omni bearing selector knob (OBS), which is located on the course indicator, are mounted on the front panel of the receiver-transmitter. The course indicator includes either a single pointer and related OFF flag for VOR/LOC indication only, or dual pointers and related OFF flags for both VOR/LOC and glide slope indications. The course indicator also incorporates a back-course lamp (BC) which lights when back-course operation is selected. In addition, when two or more radios are installed, a transmitter selector switch and a speaker-phone selector switch are provided. Each control function is described in Figure 1.

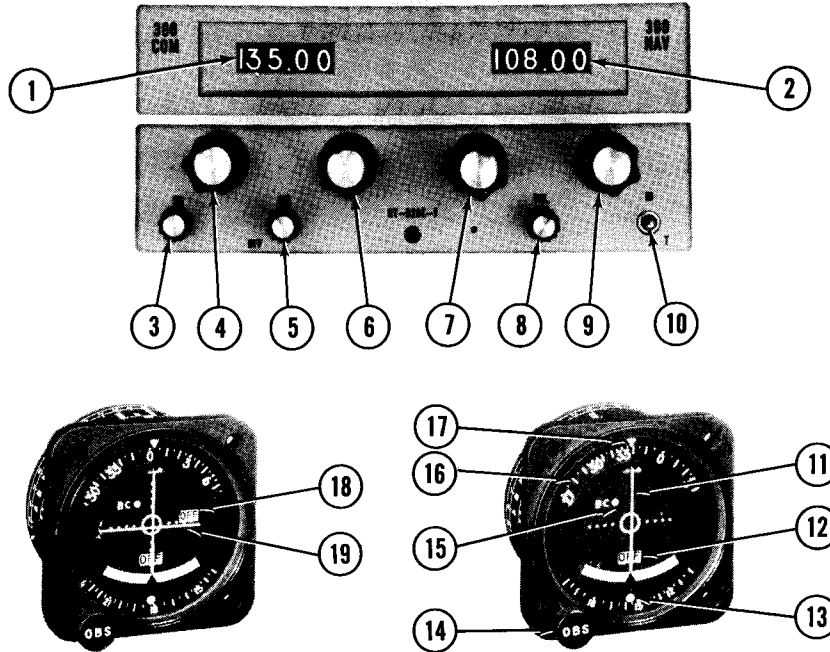

1. RECEIVER-TRANSMITTER FREQUENCY INDICATOR.
2. NAVIGATION RECEIVER FREQUENCY INDICATOR.
3. SQUELCH CONTROL - Used to adjust signal threshold necessary to activate receiver audio. Clockwise rotation increases background noise (decreases squelch action); counterclockwise rotation decreases background noise.
4. COMMUNICATION RECEIVER-TRANSMITTER MEGAHERTZ SELECTOR - Selects communication receiver-transmitter frequency in 1-MHz steps between 118 and 135 MHz.
5. OFF/ON VOLUME CONTROL - Turns complete set on and controls volume of audio from communication receiver.
6. COMMUNICATION RECEIVER-TRANSMITTER FRACTIONAL MEGAHERTZ SELECTOR - Selects communication receiver-transmitter fractional frequency in 0.05-MHz steps between 0.00 and 0.95 MHz.

Figure 1. Cessna 300 Nav/Com (Type RT-528E-1) (Sheet 1 of 2)

7. NAVIGATION RECEIVER MEGAHERTZ SELECTOR - Selects navigation receiver frequency in 1-MHz steps between 108 and 117 MHz.
8. NAVIGATION RECEIVER VOLUME CONTROL - Controls volume of audio from navigation receiver only. Clockwise rotation increases audio level.
9. NAVIGATION RECEIVER FRACTIONAL MEGAHERTZ SELECTOR - Selects navigation receiver frequency in 0.05-MHz steps between 0.00 and 0.95 MHz.
10. COMBINED IDENTIFIER SIGNAL SELECTOR AND VOR SELF-TEST SELECTOR SWITCH - When VOR station is selected in ID position, station identifier is audible; in center (unmarked) position, identifier is off; in T (momentary on) position, tests VOR navigation circuits.
11. COURSE DEVIATION POINTER - Indicates course deviation from selected omni bearing or localizer centerline.
12. OFF/TO-FROM (OMNI) INDICATOR - Operates only with VOR or localizer signal. "OFF" position (flag) indicates unreliable signal. When "OFF" position disappears, indicator shows whether selected VOR course is "TO" or "FROM" the station (if LOC frequency is selected, indicator will only show "TO").
13. RECIPROCAL COURSE INDEX - Indicates reciprocal of selected VOR course.
14. OMNI BEARING SELECTOR (OBS) - Selects desired course to or from a VOR station.
15. BC - Amber light illuminates when an optional autopilot system is installed and the autopilot's back-course button is engaged; indicates CDI needle is reversed on selected receiver when tuned to a localizer frequency (type IN-514B or IN-525B Indicators only).
16. BEARING DIAL.
17. COURSE INDEX - Indicates selected VOR course.
18. GLIDE SLOPE "OFF" FLAG - When visible, indicates unreliable glide slope signal or no glide slope signal. The flag disappears when a reliable glide slope signal is being received.
19. GLIDE SLOPE DEVIATION POINTER - Indicates deviation from normal glide slope.

Figure 1. Cessna 300 Nav/Com (Type RT-528E-1) (Sheet 2 of 2)

## SECTION 2 LIMITATIONS

There is no change to the airplane limitations when this avionic equipment is installed. However, the pilot should be aware that on many Cessna airplanes equipped with the windshield mounted glide slope antenna, pilots should avoid use of 2700  $\pm$ 100 RPM (or 1800  $\pm$ 100 RPM with a three bladed propeller) during ILS approaches to avoid propeller interference caused oscillations of the glide slope deviation pointer.

## SECTION 3 EMERGENCY PROCEDURES

There is no change to the airplane emergency procedures when this avionic equipment is installed.

## SECTION 4 NORMAL PROCEDURES

### TO TRANSMIT:

- (1) XMTR SEL Switch -- SELECT transceiver.
- (2) COM Frequency Selector Knobs -- SELECT operating frequency.
- (3) OFF/VOL Control -- ON.
- (4) Mike Button -- DEPRESS.

### TO RECEIVE:

- (1) XMTR SEL Switch -- SELECT transceiver.
- (2) SPEAKER/PHONE Switch -- SELECT desired mode.
- (3) COM/NAV Frequency Selector Knobs -- SELECT frequency.
- (4) VOL Control -- Adjust to listening level (OFF/VOL knob must be ON).
- (5) SQ Control -- ROTATE counterclockwise to decrease background noise.

### TO OPERATE IDENT FILTER:

- (1) ID-T Switch -- CENTER (unmarked) to include filter in audio circuit of both receivers.

- (2) ID-T Switch -- ID position disconnects filter from audio circuit to hear navigation station identifier (Morse Code) signal.

**NOTE**

The ID-T switch should be left in ID position for best communications reception.

**TO SELF TEST VOR NAVIGATION CIRCUITS:**

- (1) Tune to usable VOR signal from either a VOR station or a test signal.
- (2) OBS Knob -- ROTATE course index to 0°.
- (3) ID-T Switch -- T position. Vertical pointer should center and OFF-TO-FROM indicator should show FROM.
- (4) ID-T Switch -- T position and rotate OBS knob to displace course index approximately 10° to either side of 0°. Vertical pointer should deflect full scale in direction corresponding to course index displacement.
- (5) ID-T Switch -- CENTER (unmarked) position for normal VOR operation.

**NOTE**

This test does not fulfill the requirements of FAR 91.25.

## **SECTION 5**

### **PERFORMANCE**

There is no change to the airplane performance when this avionic equipment is installed. However, the installation of an externally mounted antenna or several related external antennas, will result in a minor reduction in cruise performance.





## SUPPLEMENT

### CESSNA 300 NAV/COM (720-Channel - Type RT-328T)

#### SECTION 1

#### GENERAL

The Cessna 300 Nav/Com (Type RT-328T), shown in Figure 1, consists of a panel-mounted receiver-transmitter and a single- or dual-pointer remote course indicator. The set includes a 720-channel VHF communication receiver-transmitter and a 200-channel VHF navigation receiver, both of which may be operated simultaneously.

The communication receiver-transmitter receives and transmits signals between 118.000 and 135.975 MHz in 25-kHz steps. The navigation receiver receives and interprets VHF omnidirectional and localizer signals between 108.00 and 117.95 MHz in 50-kHz steps. The communication receiver-transmitter and the navigation receiver are synthesizer-controlled and are tuned automatically when the frequency is selected.

A DME receiver-transmitter or a glide slope receiver, or both, may be interconnected with the Cessna 300 Nav/Com set for automatic selection of the associated DME or GS frequency. When a VOR frequency is selected on the Nav/Com, the associated VORTAC or VOR-DME station frequency will also be selected automatically; likewise, if a localizer frequency is selected, the associated glide slope frequency will be selected automatically.

All controls of the Cessna 300 Nav/Com, except the omni bearing selector knob (OBS), which is located on the course indicator, are mounted on the front panel of the receiver-transmitter. The course indicator includes either a single pointer and related OFF flag for VOR/LOC indication only, or dual pointers and related OFF flags for both VOR/LOC and glide slope indications. The course indicator also incorporates a back-course lamp (BC) which lights when back-course operation is selected. In addition, when two or more radios are installed, a transmitter selector switch and a speaker-phone selector switch are provided. Each control function is described in Figure 1.

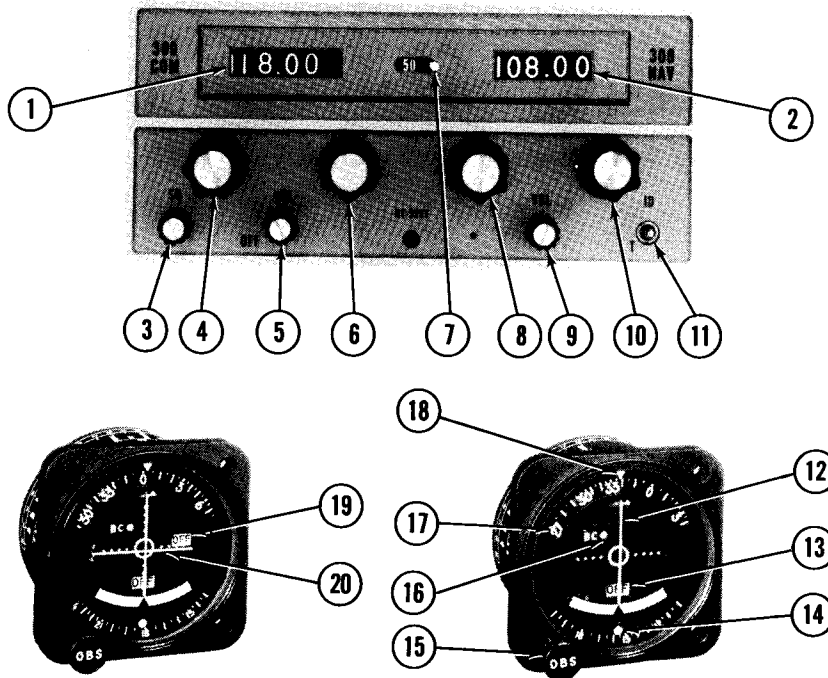

1. RECEIVER-TRANSMITTER FREQUENCY INDICATOR.
2. NAVIGATION RECEIVER FREQUENCY INDICATOR.
3. SQUELCH CONTROL - Used to adjust signal threshold necessary to activate receiver audio. Clockwise rotation increases background noise (decreases squelch action); counterclockwise rotation decreases background noise.
4. COMMUNICATION RECEIVER-TRANSMITTER MEGAHERTZ SELECTOR - Selects communication receiver-transmitter frequency in 1-MHz steps between 118 and 135 MHz. (There are two inactive positions between 135- and 118-position which are identified by the appearance of a "06" or a "07".)
5. OFF/ON VOLUME CONTROL - Turns set on and controls volume of audio from communications receiver.
6. COMMUNICATION RECEIVER-TRANSMITTER FRACTIONAL MEGAHERTZ SELECTOR. - Selects communication receiver-transmitter fractional frequency in .05-MHz steps between .000 and .950 MHz or between .025 and .975 MHz depending on position of 50-25 MHz selector switch.

Figure 1. Cessna 300 Nav/Com (Type RT-328T) (Sheet 1 of 2)

7. 50-25 FRACTIONAL MHz SELECTOR SWITCH. - In "50" position, enables communication whole MHz frequency readout to display and communication fractional MHz control to select fractional part of frequency in .05-MHz steps between .000 and .950 MHz. In "25" position, frequency display and coverage is in .05-MHz steps between .025 and .975.

NOTE

The third-decimal-place digit is not shown on the receiver-transmitter frequency readout.

8. NAVIGATION RECEIVER MEGAHERTZ SELECTOR. - Selects navigation receiver frequency in 1-MHz steps between 108 and 117 MHz; simultaneously selects paired glide slope frequency or DME channel.
9. NAVIGATION RECEIVER VOLUME CONTROL. - Controls volume of audio from navigation receiver only. Clockwise rotation increases audio level.
10. NAVIGATION RECEIVER FRACTIONAL MEGAHERTZ SELECTOR. - Selects navigation receiver frequency in .05-MHz steps between .00 and .95 MHz; simultaneously selects paired glide slope frequency or DME channel.
11. COMBINED IDENTIFIER SIGNAL SELECTOR AND VOR SELF-TEST SELECTOR SWITCH. - When VOR station is selected in ID position, station identifier is audible; in center (unmarked) position, identifier is off; in T (momentary on) position, tests VOR navigation circuits.
12. COURSE DEVIATION POINTER. - Indicates course deviation from selected omni bearing or localizer centerline.
13. OFF/TO-FROM (OMNI) INDICATOR - Operates only with VOR or localizer signal. "OFF" position (flag) indicates unreliable signal. When "OFF" position disappears, indicator shows whether selected VOR course is "TO" or "FROM" the station (if LOC frequency is selected, indicator will only show "TO").
14. RECIPROCAL COURSE INDEX - Indicates reciprocal of selected VOR course.
15. OMNI BEARING SELECTOR (OBS) - Selects desired course to or from a VOR station.
16. BC - Amber light illuminates when an optional system is installed and the autopilot's back-course button is engaged; indicates CDI needle is reversed on selected receiver when tuned to a localizer frequency (Type IN-514B or IN-525B Indicators Only).
17. BEARING DIAL.
18. COURSE INDEX - Indicates selected VOR course.
19. GLIDE SLOPE "OFF" FLAG - When visible, indicates unreliable glide slope signal or no glide slope signal. The flag disappears when a reliable glide slope signal is being received.
20. GLIDE SLOPE DEVIATION POINTER - Indicates deviation from normal glide slope.

Figure 1. Cessna 300 Nav/Com (Type RT-328T) (Sheet 2 of 2)

## SECTION 2 LIMITATIONS

There is no change to the airplane limitations when this avionic equipment is installed. However, the pilot should be aware that on many Cessna airplanes equipped with the windshield mounted glide slope antenna, pilots should avoid use of 2700  $\pm$ 100 RPM (or 1800  $\pm$ 100 RPM with a three bladed propeller) during ILS approaches to avoid propeller interference caused oscillations of the glide slope deviation pointer.

## SECTION 3 EMERGENCY PROCEDURES

There is no change to the airplane emergency procedures when this avionic equipment is installed.

## SECTION 4 NORMAL PROCEDURES

### TO TRANSMIT:

- (1) XMTR SEL Switch -- SELECT transceiver.
- (2) COM Frequency Selector Knobs -- SELECT operating frequency.
- (3) 50-25 Fractional MHz Selector Switch -- SELECT operating frequency.
- (4) OFF/VOL Control -- ON.
- (5) Mike Button -- DEPRESS.

### TO RECEIVE:

- (1) XMTR SEL Switch -- SELECT transceiver.
- (2) SPEAKER/PHONE Switch -- SELECT desired mode.
- (3) COM/NAV Frequency Selector Knobs -- SELECT operating frequency.
- (4) 50-25 Fractional MHz Selector Switch -- SELECT operating frequency (not selected for navigational frequencies).
- (5) VOL Control -- ADJUST to listening level (OFF/VOL knob must be ON).
- (6) SQ Control -- ROTATE counterclockwise to decrease background noise.

**TO OPERATE IDENT FILTER:**

- (1) ID-T Switch -- CENTER (unmarked) to include filter in audio circuit of both receivers.
- (2) ID-T Switch -- ID position disconnects filter from audio circuit to hear navigation station identifier (Morse Code) signal.

**NOTE**

The ID-T switch should be left in ID position for best communications reception.

**TO SELF TEST VOR NAVIGATION CIRCUITS:**

- (1) Tune to usable VOR signal from either a VOR station or a test signal.
- (2) OBS Knob -- ROTATE course index to 0°.
- (3) ID-T Switch -- T position. Vertical pointer should center and OFF-TO-FROM indicator should show FROM.
- (4) ID-T Switch -- T position and rotate OBS knob to displace course index approximately 10° to either side of 0°. Vertical pointer should deflect full scale in direction corresponding to course index displacement.
- (5) ID-T Switch -- CENTER (unmarked) position for normal VOR operation.

**NOTE**

This test does not fulfill the requirements of FAR 91.25.

## **SECTION 5 PERFORMANCE**

There is no change to the airplane performance when this avionic equipment is installed. However, the installation of an externally mounted antenna or several related external antennas, will result in a minor reduction in cruise performance.



# SUPPLEMENT

## CESSNA 300 ADF

### (Type R-546E)

#### SECTION 1

#### GENERAL

The Cessna 300 ADF is a panel-mounted, digitally tuned automatic direction finder. It is designed to provide continuous 1 kHz digital tuning in the frequency range of 200 kHz to 1,699 kHz and eliminates the need for mechanical band switching. The system is comprised of a receiver, loop antenna, bearing indicator and a sense antenna. In addition, when two or more radios are installed, speaker-phone selector switches are provided. Each control function is described in Figure 1.

The Cessna 300 ADF can be used for position plotting and homing procedures, and for aural reception of amplitude-modulated (AM) signals.

With the function selector knob at ADF, the Cessna ADF provides a visual indication, on the bearing indicator, of the bearing to the transmitting station relative to the nose of the airplane. This is done by combining signals from the sense antenna with signals from the loop antenna.

With the function selector knob at REC, the Cessna ADF uses only the sense antenna and operates as a conventional low-frequency receiver. In the REC, position, the indicator will automatically move to the pointer stow position. This feature alerts the operator to non-ADF operation by positioning and retaining the pointer at the 3:00 o'clock position.

The Cessna 300 ADF is designed to receive transmission from the following radio facilities: commercial broadcast stations, low-frequency range stations, FAA radio beacons, and ILS compass locators.

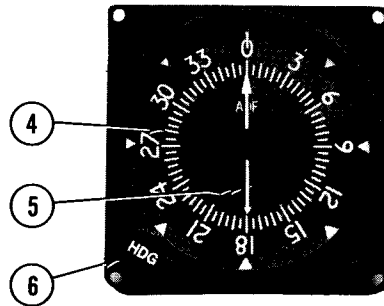
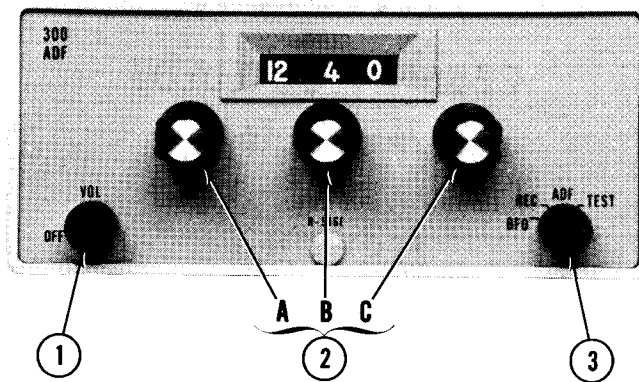

1. **OFF/VOL** - Controls primary power and audio output level. Clockwise rotation from OFF position applies primary power to receiver; further clockwise rotation increases audio level.
2. **FREQUENCY SELECTORS** - Knob (A) selects 100-kHz increments of receiver frequency, knob (B) selects 10-kHz increments, and knob (C) selects 1-kHz increments.

Figure 1. Cessna 300 ADF Operating Controls and Indicators (Sheet 1 of 2)



3. FUNCTION

BFO: Set operates as communication receiver using only sense antenna and activates 1000-Hz tone beat frequency oscillator to permit coded identifier of stations transmitting keyed CW signals (Morse Code) to be heard.

REC: Set operates as standard communication receiver using only sense antenna.

NOTE

In this position an automatic pointer stow feature will alert the pilot to non-ADF operation by positioning and retaining the pointer at the 3:00 o'clock position when the 300 ADF is in the REC function.

ADF: Set operates as automatic direction finder using loop and sense antennas.

TEST: Momentary-on position used during ADF operation to test bearing reliability. When held in TEST position, slews indicator pointer clockwise; when released, if bearing is reliable, pointer returns to original bearing position.

4. INDEX (ROTATABLE CARD) - Indicates relative, magnetic, or true heading of aircraft.
5. POINTER - Indicates station bearing in degrees of azimuth, relative to the nose of the aircraft. When heading control is adjusted, indicates relative, magnetic, or true bearing from which radio signal is being received.
6. HEADING CONTROL - Rotates card to induce relative, magnetic, or true bearing information.

Figure 1. Cessna 300 ADF Operating Controls and Indicators (Sheet 2 of 2)

## SECTION 2 LIMITATIONS

There is no change to the airplane limitations when this avionic equipment is installed.

## SECTION 3 EMERGENCY PROCEDURES

There is no change to the airplane emergency procedures when this avionic equipment is installed.

## SECTION 4 NORMAL PROCEDURES

### TO OPERATE AS A COMMUNICATIONS RECEIVER ONLY:

- (1) OFF/VOL Control -- ON.
- (2) Function Selector Knob -- REC.

#### NOTE

Indicator's pointer will stow at a 3:00 o'clock position to alert the pilot to non-ADF operation.

- (3) Frequency Selector Knobs -- SELECT operating frequency.
- (4) ADF SPEAKER/PHONE Switch -- SELECT speaker or phone position as desired.
- (5) VOL Control -- ADJUST to desired listening level.

### TO OPERATE AS AN AUTOMATIC DIRECTION FINDER:

- (1) OFF/VOL Control -- ON.
- (2) Frequency Selector Knobs -- SELECT operating frequency.
- (3) ADF SPEAKER/PHONE Switch -- SELECT speaker or phone position.
- (4) Function Selector Knob -- ADF position and note relative bearing on indicator.
- (5) VOL Control -- ADJUST to desired listening level.

#### NOTE

When switching stations place function selector knob in REC position. Then, after station has been selected,

return selector knob to ADF to resume automatic direction finder operation (this practice prevents the bearing indicator from swinging back and forth as frequency dial is rotated).

**TO TEST RELIABILITY OF AUTOMATIC DIRECTION FINDER:**

- (1) Function Selector Knob -- ADF position and note relative bearing on indicator.
- (2) Function Selector Knob -- TEST position and observe that pointer moves away from relative bearing at least 10 to 20 degrees.
- (3) Function Selector Knob -- ADF position and observe that pointer returns to same relative bearing as in step (1).

**TO OPERATE BFO:**

- (1) OFF/VOL Control -- ON.
- (2) Function Selector Knob -- BFO.
- (3) Frequency Selector Knobs -- SELECT operating frequency.
- (4) ADF SPEAKER/PHONE Switch -- SELECT speaker or phone position.
- (5) VOL Control -- ADJUST to desired listening level.

**NOTE**

A 1000-Hz tone is heard in the audio output when a CW signal (Morse Code) is tuned in properly.

## **SECTION 5 PERFORMANCE**

There is no change to the airplane performance when this avionic equipment is installed. However, the installation of an externally mounted antenna or several related external antennas, will result in a minor reduction in cruise performance.



**SUPPLEMENT**

**CESSNA 300 TRANSPONDER**  
**(Type RT-359A)**

**AND**

**OPTIONAL ALTITUDE ENCODER**  
**(Type EA-401A)**

**SECTION 1**

**GENERAL**

The Cessna 300 Transponder (Type RT-359A), shown in Figure 1, is the airborne component of an Air Traffic Control Radar Beacon System (ATCRBS). The transponder enables the ATC ground controller to "see" and identify the aircraft, while in flight, at distances beyond the primary radar range.

The Cessna 300 Transponder consists of a panel-mounted unit and an externally-mounted antenna. The transponder receives interrogating pulse signals on 1030 MHz and transmits coded pulse-train reply signals on 1090 MHz. It is capable of replying to Mode A (aircraft position identification) and Mode C (altitude information) interrogations on a selective reply basis on any of 4,096 information code selections. When an optional panel-mounted EA-401 altitude encoder (not part of a standard 300 Transponder system) is included in the avionic configuration, the transponder can provide altitude reporting in 100-foot increments between -1000 and +35,000 feet.

All Cessna 300 Transponder operating controls, with the exception of the optional altitude encoder's barometric pressure set knob, are located on the front panel of the unit. The barometric pressure set knob is located on the altitude encoder. Function of the operating controls is described in Figure 1.

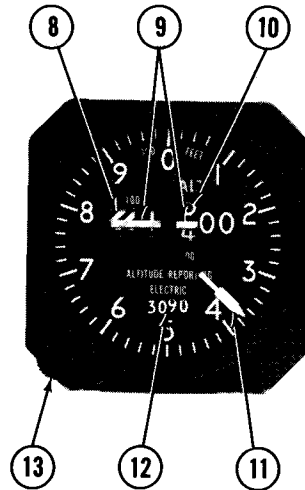
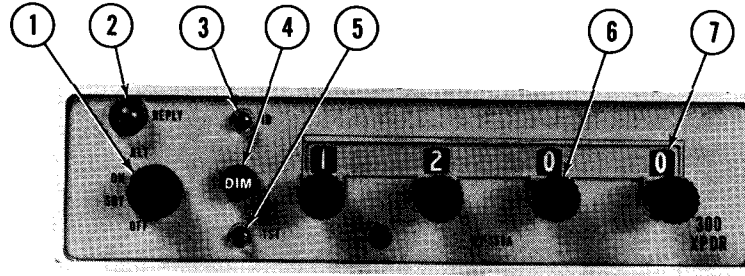

1. **FUNCTION SWITCH** - Controls application of power and selects transponder operating mode, as follows:
  - OFF - Removes power from transponder (turns set off).
  - SBY - Applies power for equipment warm-up.
  - ON - Applies operating power and enables transponder to transmit Mode A reply pulses.
  - ALT - Applies operating power and enables transponder to transmit either Mode A reply pulses or Mode C altitude information pulses selected automatically by the interrogating signal.
2. **REPLY LAMP** - Provides visual indication of transponder replies. During normal operation, lamp flashes when reply pulses are transmitted; when special pulse identifier is

Figure 1. Cessna 300 Transponder (Sheet 1 of 2)

- selected, lamp glows steadily for duration of IDENT pulse transmission. (Reply Lamp will also glow steadily during initial warm-up period.)
3. IDENT SWITCH - When depressed, selects special pulse identifier to be transmitted with transponder reply to effect immediate identification of aircraft on ground controller's display. (Reply Lamp will glow steadily during duration of IDENT pulse transmission.)
  4. DIMMER CONTROL - Allows pilot to control brilliance of reply lamp.
  5. SELF-TEST SWITCH - When depressed, causes transponder to generate a self-interrogating signal to provide a check of transponder operation. (Reply Lamp will illuminate to verify self test operation.)
  6. REPLY-CODE SELECTOR SWITCHES (4) - Selects assigned Mode A (or Mode C) reply code.
  7. REPLY-CODE INDICATORS (4) - Displays selected Mode A (or Mode C) reply code.
  8. 1000-FOOT DRUM TYPE INDICATOR - Provides digital altitude readout in 1000-foot increments between -1000 feet and +35,000 feet.
  9. OFF INDICATOR WARNING FLAG - Flag appears when power is removed from the system.
  10. 100-FOOT DRUM TYPE INDICATOR - Provides digital altitude readout in 100-foot increments between 0 feet and 1000 feet.
  11. 20-FOOT INDICATOR NEEDLE - Indicates altitude in 20-foot increments between 0 feet and 1000 feet.
  12. BAROMETRIC PRESSURE SET INDICATOR - DRUM TYPE - Indicates selected barometric pressure in the range of 27.9 to 31.0 inches of mercury.
  13. BAROMETRIC PRESSURE SET KNOB - Dials in desired barometric pressure setting in the range of 27.9 to 31.0 inches of mercury.

Figure 1. Cessna 300 Transponder (Sheet 2 of 2)

## SECTION 2 LIMITATIONS

There is no change to the airplane limitations when this avionic equipment is installed.

## SECTION 3 EMERGENCY PROCEDURES

TO TRANSMIT AN EMERGENCY SIGNAL:

- (1) Function Switch -- ON.
- (2) Reply-Code Selector Switches -- SELECT 7700 operating code.
- (3) ID Switch -- DEPRESS to effect immediate identification of aircraft on ground controller's display.
- (4) DIM Control -- ADJUST light brilliance of reply lamp.

TO TRANSMIT A SIGNAL REPRESENTING LOSS OF ALL COMMUNICATIONS:

- (1) Function Switch -- ON.
- (2) Reply-Code Selector Switches -- SELECT 7700 operating code for 1 minute, then select 7600 operating code for 15 minutes and then repeat this procedure for remainder of flight.
- (3) ID Switch -- DEPRESS to effect immediate identification of aircraft on ground controller's display.
- (4) DIM Control -- ADJUST light brilliance of reply lamp.

## SECTION 4 NORMAL PROCEDURES

BEFORE TAKEOFF AND WHILE TAXIING:

- (1) Function Switch -- SBY.

TO TRANSMIT MODE A (AIRCRAFT POSITION IDENTIFICATION) CODES IN FLIGHT:

- (1) Reply-Code Selector Switches -- SELECT assigned code.



- (2) Function Switch -- ON.
- (3) DIM Control -- ADJUST light brilliance of reply lamp.

NOTE

During normal operation with function switch in ON position, REPLY lamp flashes indicating transponder replies to interrogations.

- (4) ID Button -- DEPRESS momentarily when instructed by ground controller to "squawk IDENT" (REPLY lamp will glow steadily, indicating IDENT operation).

TO TRANSMIT MODE C (ALTITUDE INFORMATION) CODES IN FLIGHT:

- (1) Altitude Encoder Barometric Pressure Set Knob -- DIAL assigned barometric pressure.
- (2) Reply-Code Selector Switches -- SELECT assigned code.
- (3) Function Switch -- ALT.

NOTE

When directed by ground controller to "stop altitude squawk", turn Function Switch to ON for Mode A operation only.

NOTE

Pressure altitude is transmitted, and conversion to indicated altitude is done in ATC computers. Altitude squawk will agree with indicated altitude when altimeter setting in use by the ground controller is set in the altitude encoder.

- (4) DIM Control -- ADJUST light brilliance of reply lamp.

TO SELF-TEST TRANSPONDER OPERATION:

- (1) Function Switch -- SBY and wait 30 seconds for equipment to warm-up.
- (2) Function Switch -- ON.
- (3) TST Button -- DEPRESS (Reply lamp should light brightly regardless of DIM control setting).

## SECTION 5 PERFORMANCE

There is no change to the airplane performance when this avionic equipment is installed. However, the installation of an externally mounted antenna or several related external antennas, will result in a minor reduction in cruise performance.

## **SUPPLEMENT**

### **DME**

**(Type 190)**

#### **SECTION 1**

##### **GENERAL**

The DME 190 (Distance Measuring Equipment) system consists of a panel mounted 200 channel UHF transmitter-receiver and an externally mounted antenna. The transceiver has a single selector knob that changes the DME's mode of operation to provide the pilot with: distance-to-station, time-to-station, or ground speed readouts. The DME is designed to operate in altitudes up to a maximum of 50,000 feet at ground speeds up to 250 knots and has a maximum slant range of 199.9 nautical miles.

The DME can be channeled independently or by a remote NAV set. When coupled with a remote NAV set, the MHz digits will be covered over by a remote (REM) flag and the DME will utilize the frequency set by the NAV set's channeling knobs. When the DME is not coupled with a remote NAV set, the DME will reflect the channel selected on the DME unit. The transmitter operates in the frequency range of 1041 to 1150 MHz and is paired with 108 to 117.95 MHz to provide automatic DME channeling. The receiver operates in the frequency range of 978 to 1213 MHz and is paired with 108 to 117.95 MHz to provide automatic DME channeling.

All operating controls for the DME are mounted on the front panel of the DME and are described in Figure 1.

#### **SECTION 2**

##### **LIMITATIONS**

There is no change to the airplane limitations when this avionic equipment is installed.

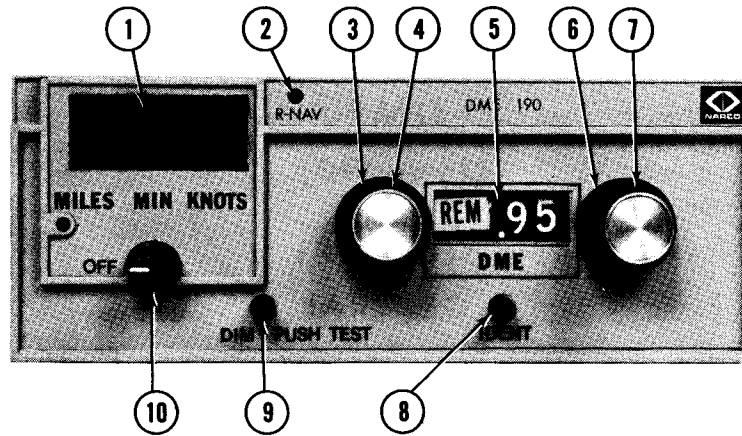

1. **READOUT WINDOW** - Displays function readout in miles (distance-to-station), minutes (time-to-station) or knots (ground speed).
2. **R-NAV INDICATOR LAMP** - The green R-NAV indicator lamp is provided to indicate the DME is coupled to an R-NAV system. Since this DME is not factory installed with an R-NAV system on Cessna airplanes, the R-NAV indicator lamp should never be illuminated. However, if an R-NAV system is coupled to the DME, and when in R-NAV mode, the R-NAV lamp will light which indicates that the distance readout is to the "way point" instead of the DME station. The DME can only give distance (Miles) in R-NAV mode.
3. **REMOTE CHANNELING SELECTOR** - This knob is held stationary by a stop when not coupled to a remote NAV receiver. When coupled to a remote NAV receiver, a stop in the selector is removed and the selector becomes a two position selector. In the first position, the DME will utilize the frequency set by the DME channeling knobs. In the second position, the MHz digits will utilize the frequency set by the NAV unit's channeling knobs.
4. **WHOLE MEGAHERTZ SELECTOR KNOB** - Selects operating frequency in 1-MHz steps between 108 and 117 MHz.
5. **FREQUENCY INDICATOR** - Shows operating frequency selected on the DME or displays remote (REM) flag to indicate DME is operating on a frequency selected by a remote NAV receiver.

Figure 1. DME 190 Operating Controls (Sheet 1 of 2)

6. FRACTIONAL MEGAHERTZ SELECTOR KNOB - Selects operating frequency in 50 kHz steps. This knob has two positions, one for the 0 and one for the 5.
7. FRACTIONAL MEGAHERTZ SELECTOR KNOB - Selects operating frequency in tenths of a Megahertz (0-9).
8. IDENT KNOB - Rotation of this control increases or decreases the volume of the received station's Ident signal. An erratic display, accompanied by the presence of two Ident signals, can result if the airplane is flying in an area where two stations, using the same frequency, are transmitting.
9. DIM/PUSH TEST KNOB -
  - DIM: Controls the brilliance of the readout lamp's segments. Rotate the control as desired for proper lamp illumination in the function window (The frequency window is dimmed by the aircraft's radio light dimming control).
  - PUSH TEST: This control is used to test the illumination of the readout lamps, with or without being tuned to a station. Press the control, a readout of 188.8 should be seen with the mode selector switch in the MIN or KNOTS position. The decimal point along with 188.8 will light in the MILES mode. When the control is released, and had the DME been channeled to a nearby station, the distance to that station will appear. If the station channeled was not in range, a "bar" readout will be seen (--.- or --.-).
10. MODE SELECTOR SWITCH -
  - OFF: Turns the DME OFF.
  - MILES: Allows a digital readout to appear in the window which represents slant range (in nautical miles) to or from the channeled station.
  - MIN: Allows a digital readout (in minutes) to appear in the window that it will take the airplane to travel the distance to the channeled station. This time is only accurate when flying directly TO the station and after the ground speed has stabilized.
  - KNOTS: Allows a digital readout (in knots) to appear in the window that is ground speed and is valid only after the stabilization time (approximately 2 minutes) has elapsed when flying directly TO or FROM the channeled station.

Figure 1. DME 190 Operating Controls (Sheet 2 of 2)

### SECTION 3 EMERGENCY PROCEDURES

There is no change to the airplane emergency procedures when this avionic equipment is installed.

### SECTION 4 NORMAL PROCEDURES

TO OPERATE:

- (1) Mode Selector Switch -- SELECT DME function.
- (2) Frequency Selector Knobs -- SELECT desired operating frequency and allow equipment to warm-up at least 2 minutes.

NOTE

If frequency is set on remote NAV receiver, place remote channeling selector in the REM position.

- (3) PUSH TEST Control -- PUSH and observe reading of 188.8 in function window.
- (4) DIM Control -- ADJUST.
- (5) IDENT Control -- ADJUST audio output in speaker.
- (6) Mode Selector Functions:
  - MILES Position -- Distance-to-Station is slant range in nautical miles.
  - MIN Position -- Time-to-Station when flying directly to station.
  - KNOTS Position -- Ground Speed in knots when flying directly to or from station.

**CAUTION**

After the DME 190 has been turned OFF, do not turn it on again for 5 seconds to allow the protective circuits to reset.

### SECTION 5 PERFORMANCE

There is no change to the airplane performance when this avionic equipment is installed. However, the installation of an externally mounted antenna or several related external antennas, will result in a minor reduction in cruise performance.

# **SUPPLEMENT**

## **HF TRANSCEIVER**

### **(Type PT10-A)**

#### **SECTION 1**

##### **GENERAL**

The PT10-A HF Transceiver, shown in Figure 1, is a 10-channel AM transmitter-receiver which operates in the frequency range of 2.0 to 18.0 Megahertz. The transceiver is automatically tuned to the operating frequency by a Channel Selector. The operating controls for the unit are mounted on the front panel of the transceiver. The system consists of a transceiver, antenna load box, fixed wire antenna and associated wiring.

The Channel Selector Knob determines the operating frequency of the transmitter and receiver. The frequencies of operation are shown on the frequency chart adjacent to the channel selector.

The VOLUME control incorporates the power switch for the transceiver. Clockwise rotation of the volume control turns the set on and increases the volume of audio.

The meter on the face of the transceiver indicates transmitter output.

The system utilizes the airplane microphone, headphone and speaker. When two or more radios are installed, a transmitter selector switch and a speaker-phone switch are provided.

#### **SECTION 2**

##### **LIMITATIONS**

There is no change to the airplane limitations when this avionic equipment is installed.

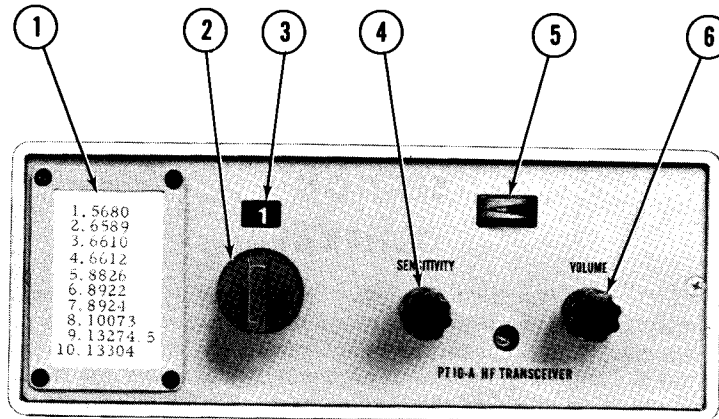

1. **FREQUENCY CHART** - Shows the frequency of the channel in use (frequencies shown may vary and are shown for reference purposes only).
2. **CHANNEL SELECTOR** - Selects channels 1 thru 10 as listed in the frequency chart.
3. **CHANNEL READOUT WINDOW** - Displays channel selected in frequency chart.
4. **SENSITIVITY CONTROL** - Controls the receiver sensitivity for audio gain.
5. **ANTENNA TUNING METER** - Indicates the energy flowing from the transmitter into the antenna. The optimum power transfer is indicated by the maximum meter reading.
6. **ON/OFF VOLUME CONTROL** - Turns complete set on and controls volume of audio.

Figure 1. HF Transceiver (Type PT10-A)



### SECTION 3 EMERGENCY PROCEDURES

There is no change to the airplane emergency procedures when this avionic equipment is installed.

### SECTION 4 NORMAL PROCEDURES

TO OPERATE:

- (1) XMTR SEL Switch -- SELECT transceiver.
- (2) SPEAKER/PHONE Switch -- SELECT desired mode.
- (3) VOLUME Control -- ON (allow equipment to warm up and adjust audio to comfortable listening level).
- (4) Frequency Chart -- SELECT desired operating frequency.
- (5) Channel Selector -- DIAL in frequency selected in step 4.
- (6) SENSITIVITY Control -- ROTATE clockwise to maximum position.

#### NOTE

If receiver becomes overloaded by very strong signals, back off SENSITIVITY control until background noise is barely audible.

#### NOTE

The antenna tuning meter indicates the energy flowing from the airplane's transmitter into the antenna. The optimum power transfer is indicated by the maximum meter reading.

- (7) To Transmit -- DEPRESS microphone switch button and speak directly into microphone.
- (8) To Receive -- RELEASE microphone switch button.

### SECTION 5 PERFORMANCE

There is no change to the airplane performance when this avionic equipment is installed. However, the installation of an externally mounted antenna or several related external antennas, will result in a minor reduction in cruise performance.



# SUPPLEMENT

## SSB HF TRANSCEIVER

### (Type ASB-125)

#### SECTION 1

#### GENERAL

The ASB-125 HF transceiver is an airborne, 10-channel, single sideband (SSB) radio with a compatible amplitude modulated (AM) transmitting-receiving system for long range voice communications in the 2 to 18 MHz frequency range. The system consists of a panel mounted receiver/exciter, a remote mounted power amplifier/power supply, an antenna coupler and an externally mounted, fixed wire, medium/high frequency antenna.

A channel selector knob determines the operating frequency of the transceiver which has predetermined crystals installed to provide the desired operating frequencies. A mode selector control is provided to supply the type of emission required for the channel, either sideband, AM or telephone for public correspondence. An audio knob, clarifier knob and squelch knob are provided to assist in audio operation during receive. In addition to the aforementioned controls, which are all located on the receiver/exciter, a meter is incorporated to provide antenna loading readouts.

The system utilizes the airplane microphone, headphone and speaker. When two or more radios are installed, a transmitter selector switch and a speaker-phone switch are provided.

#### SECTION 2

#### LIMITATIONS

There is no change to the airplane limitations when this avionic equipment is installed. However, the pilot should be aware of the two following radio limitations:

- (1) For sideband operation in the United States, Canada and various

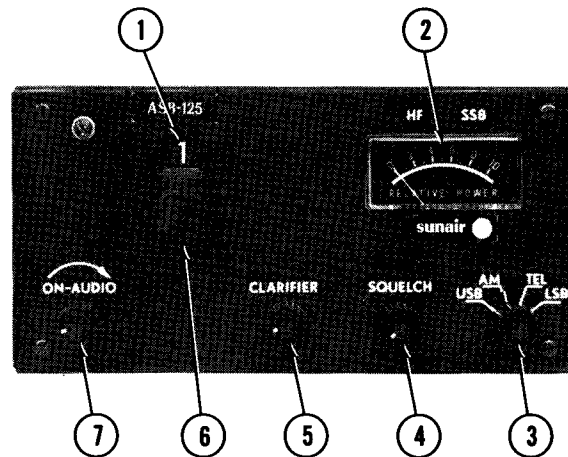

1. CHANNEL WINDOW - Displays selected operating channel.
2. RELATIVE POWER METER - Indicates relative radiated power of the power amplifier/antenna system.
3. MODE SELECTOR CONTROL - Selects one of the desired operating modes:
  - USB - Selects upper side band operation for long range voice communications.
  - AM - Selects compatible AM operation and full AM reception.
  - TEL - Selects upper sideband with reduced carrier, used for public correspondence telephone and ship-to-shore.
  - LSB - (Optional) Selects lower sideband operation (not legal in U.S., Canada and most other countries).
4. SQUELCH CONTROL - Used to adjust signal threshold necessary to activate receiver audio. Clockwise rotation increases background noise (decreases squelch action); counterclockwise rotation decreases background noise.
5. CLARIFIER CONTROL - Used to "clarify" single sideband speech during receive while in USB mode only.
6. CHANNEL SELECTOR CONTROL - Selects desired channel. Also selects AM mode if channel frequency is 2003 kHz, 2182 kHz or 2638 kHz.
7. ON - AUDIO CONTROL - Turns set ON and controls receiver audio gain.

Figure 1. SSB HF Transceiver Operating Controls

other countries, only the upper sideband may be used. Use of lower side band is prohibited.

- (2) Only AM transmissions are permitted on frequencies 2003 kHz, 2182 kHz, and 2638 kHz. The selection of these channels will automatically select the AM mode of transmission.

### SECTION 3 EMERGENCY PROCEDURES

There is no change to the airplane emergency procedures when this avionic equipment is installed.

### SECTION 4 NORMAL PROCEDURES

TO OPERATE:

- (1) XMTR SEL Switch -- SELECT transceiver.
- (2) SPEAKER/PHONE Switch -- SELECT.
- (3) ON-AUDIO Control -- ON (allow equipment to warm up for 5 minutes for sideband or one minute for AM operation and adjust audio to comfortable listening level).
- (4) Channel Selector Control -- SELECT desired operating frequency.
- (5) Mode Selector Control -- SELECT operating mode.
- (6) Squelch Control -- ADJUST the audio gain counterclockwise for normal noise output, then slowly adjust clockwise until the receiver is silent.
- (7) Clarifier Control -- ADJUST when upper single sideband RF signal is being received for maximum clarity.
- (8) Mike Button -- DEPRESS to transmit voice communications.

#### NOTE

Voice communications are not available in the LSB mode.

#### NOTE

Lower sideband (LSB) mode is not legal in the U.S., Canada, and most other countries.

## **SECTION 5**

### **PERFORMANCE**

There is no change to the airplane performance when this avionic equipment is installed. However, the installation of an externally mounted antenna or several related external antennas, will result in a minor reduction in cruise performance.

# SUPPLEMENT

## CESSNA 400 ADF

### (Type R-446A)

#### SECTION 1

#### GENERAL

The Cessna 400 ADF is an automatic direction finder set which provides continuous, visual bearing indications of the direction from which an RF signal is being received. It can be used for plotting position, for homing, and for aural reception of AM signals between 200 kHz and 1699 kHz. In addition, a crystal-controlled, beat frequency oscillator (BFO) permits coded identifier of stations transmitting keyed CW signals (Morse Code) to be heard.

The basic units of the Cessna 400 ADF are an R-446A Receiver with dual frequency selectors, a goniometer-indicator (IN-346A, IN-346B, IN-346C, or IN-346D), and sense and loop antennas. The receiver and goniometer-indicator are panel-mounted units. The sense and loop antennas are mounted on the external airplane surfaces. Operating controls for the Cessna 400 ADF are mounted on the receiver front panel. The goniometer-indicator presents station bearing in degrees of azimuth. An automatic pointer-stow feature alerts the operator to non-ADF operation by slewing the pointer to the 3:00 o'clock position when the REC mode is selected. An optional RA-446A, RA-346A, or RA-346B receiver accessory may be substituted for the goniometer-indicator to supply the goniometer function for driving a conventional ADF indicator or a RMI.

The frequency range of the Cessna 400 ADF is electronically divided into three bands: 200-399 kHz, 400-799 kHz, and 800-1699 kHz. Frequency spacing within each band is in 1-kHz increments. The operating frequency and band are selected by a four-section Minilever switch which displays a digital readout of the frequency selected and supplies a binary code to control the logic circuits within the set. A secondary (standby) operating frequency is selected by another four-section Minilever switch. Frequency control of the ADF is switched to the primary or the secondary operating frequency by a toggle switch. The operating modes (ADF and REC) are selected by individual pushbutton switches. Additional pushbutton switches are used to select the BFO and to test signal reliability during ADF operation. Operating controls for the Cessna 400 ADF are shown and described in Figure 1.

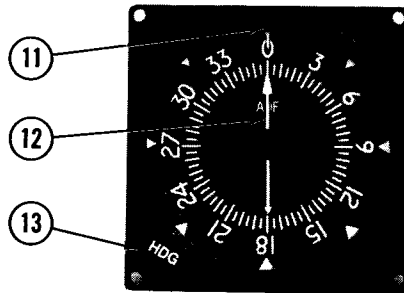
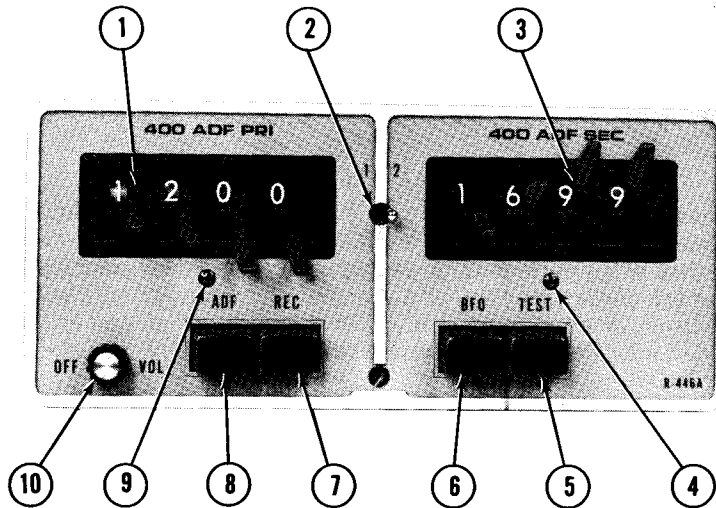

Figure 1. Cessna 400 ADF Operating Controls and Indicator  
(Sheet 1 of 2)



1. PRI (PRIMARY FREQUENCY SELECTOR) - Selects and displays "primary" frequency.
2. 1-2 - The "1" position activates "primary" (PRI) frequency. The "2" position activates "secondary" (SEC) frequency.
3. SEC (SECONDARY FREQUENCY SELECTOR) - Selects and displays "secondary" frequency.
4. SECONDARY RESELECT LAMP - Lamp will flash only when "secondary" (SEC) frequency selection is outside of operating range of the receiver and 1-2 switch is in the "2" position.
5. TEST - Momentary-on switch used only with ADF function to test bearing reliability. When held depressed, slews indicator pointer; when released, if bearing is reliable, pointer returns to original position.
6. BFO - Pushed in: Activates beat frequency oscillator tone to permit coded identifier of stations transmitting keyed CW signals (Morse Code) to be heard.
7. REC - Pushed in: Selects receive mode (set operates as a standard communications receiver using sense antenna only).

NOTE

In this position an automatic pointer stow feature will alert the pilot to non-ADF operation by positioning and retaining the pointer at the 3:00 o'clock position when the 400 ADF is in the REC function.

8. ADF - Pushed in: Selects ADF mode (set operates as automatic direction finder using loop and sense antennas).
9. PRIMARY RESELECT LAMP - Lamp will flash only when "primary" (PRI) frequency selection is outside of operating range of the receiver and 1-2 switch is in the "1" position.
10. OFF-VOL - Turns set on or off and adjusts receiver volume.
11. INDEX - Fixed reference line for dial rotation adjustment.
12. POINTER - When HDG control is adjusted, indicates either relative, magnetic, or true bearings of a radio station.
13. HDG - Rotates dial to facilitate relative, magnetic, or true bearing information.

Figure 1. Cessna 400 ADF Operating Controls and Indicator  
(Sheet 2 of 2)

## SECTION 2 LIMITATIONS

There is no change to the airplane limitations when this avionic equipment is installed.

## SECTION 3 EMERGENCY PROCEDURES

There is no change to the airplane emergency procedures when this avionic equipment is installed.

## SECTION 4 NORMAL PROCEDURES

TO OPERATE AS A COMMUNICATIONS RECEIVER ONLY:

- (1) OFF/VOL Control -- ON.
- (2) REC Pushbutton -- PUSH in.

### NOTE

ADF indicator pointer will stow at a 90-degree position to alert the pilot to non-ADF operation.

- (3) PRI Frequency Selectors -- SELECT desired operating frequency.
- (4) SEC Frequency Selectors -- SELECT desired operating frequency.
- (5) 1-2 Selector Switch -- 1 position.

### NOTE

1-2 selector switch can be placed in the 2 position for operation on secondary frequency. The re-select lamp will flash only when frequency selection is outside of operating range of the receiver.

- (6) ADF SPEAKER/PHONE Switch -- SELECT speaker or phone position.

- (7) VOL Control -- ADJUST to desired listening level.

TO OPERATE AS AN AUTOMATIC DIRECTION FINDER:

- (1) OFF/VOL Control -- ON.
- (2) PRI Frequency Selectors -- SELECT desired operating frequency.
- (3) SEC Frequency Selectors -- SELECT desired operating frequency.
- (4) 1-2 Selector Switch -- 1 position.

NOTE

1-2 selector switch can be placed in the 2 position for operation on secondary frequency. The re-select lamp will flash only when frequency selection is outside of operating range of the receiver.

- (5) ADF SPEAKER/PHONE Switch -- SELECT speaker or phone position as desired.
- (6) ADF Pushbutton -- PUSH in and note relative bearing on ADF indicator.
- (7) HDG Control -- SET goniometer-indicator dial so that index indicates magnetic or true heading of airplane. Pointer indicates bearing to station.
- (8) VOL Control -- ADJUST to desired listening level.

NOTE

When switching stations, place function pushbutton in the REC position. Then, after station has been selected, place function pushbutton in the ADF position to resume automatic direction finder operation. (This practice prevents the bearing indicator from swinging back and forth as frequency dial is rotated).

TO TEST RELIABILITY OF AUTOMATIC DIRECTION FINDER:

- (1) ADF Pushbutton -- PUSH in and note relative bearing on indicator.
- (2) TEST Pushbutton -- PUSH in and hold TEST button until indicator pointer slews off indicated bearing at least 10 to 20 degrees.
- (3) Indicator Pointer -- Observe that pointer returns to the same relative bearing as in step (1).

TO OPERATE BFO:

- (1) OFF/VOL Control -- ON.

- (2) ADF SPEAKER/PHONE Switch -- SELECT speaker or phone position.
- (3) BFO Pushbutton -- PUSH in.
- (4) 1-2 Selector Switch -- SELECT 1 position to activate PRI frequency or 2 to activate SEC frequency that is transmitting keyed CW signals (Morse Code).
- (5) VOL Control -- ADJUST to desired listening level.

**NOTE**

A 1000-Hz tone is heard in the audio output when CW signal (Morse Code) is tuned in properly.

## **SECTION 5**

### **PERFORMANCE**

There is no change to the airplane performance when this avionic equipment is installed. However, the installation of an externally mounted antenna or several related external antennas, will result in a minor reduction in cruise performance.

## SUPPLEMENT

# CESSNA 400 MARKER BEACON

(Type R-402A)

## SECTION 1

### GENERAL

The system consists of a 75 MHz marker beacon receiver, three indicator lights, one speaker/phone switch, a light dimming control, an ON/OFF/VOLUME control, and a 75 MHz marker beacon antenna. In addition, on 150, 182, 206, 207, 210 and 337 series models, a HI-LO sensitivity selector switch and a press-to-test button are provided. On all 172, 177, 177RG, 180 and 185 series models, a single, three position switch is provided for HI-LO sensitivity selection or test selection.

This system provides visual and aural indications of 75 MHz ILS marker beacon signals as the marker is passed. The following table lists the three most currently used marker facilities and their characteristics.

### MARKER FACILITIES

MARKER	IDENTIFYING TONE	LIGHT*
Inner	Continuous 6 dots/sec (3000 Hz)	White
Middle	Alternate dots and dashes (1300 Hz)	Amber
Outer	2 dashes/sec (400 Hz)	Blue

\* When the identifying tone is keyed, the respective indicating light will blink accordingly.

Operating controls and indicator lights are shown and described in Figure 1.

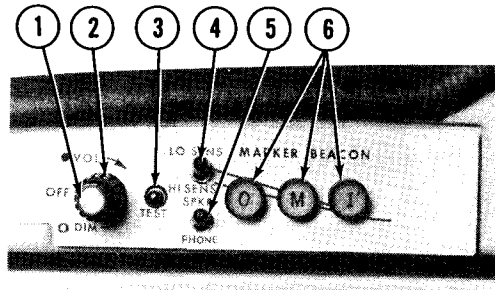

TYPICAL INSTALLATION  
ON ALL 150 MODEL SERIES

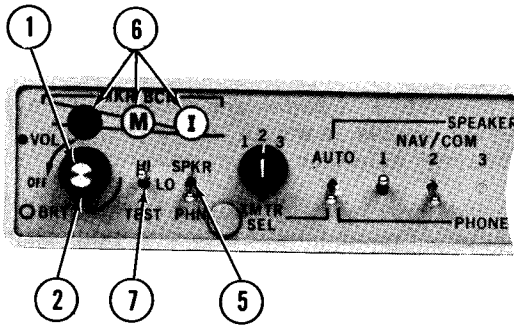

TYPICAL INSTALLATION  
ON ALL 172, 177, 177RG,  
180 & 185 MODEL SERIES

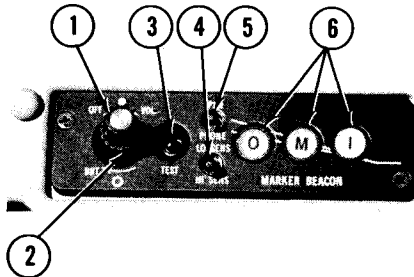

TYPICAL INSTALLATION  
ON ALL 337 MODEL SERIES

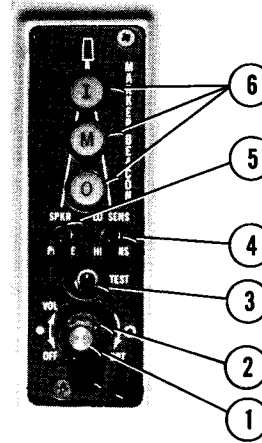

TYPICAL INSTALLATION  
ON ALL 182, 206, 207  
& 210 MODEL SERIES

Figure 1. Cessna 400 Marker Beacon Operating Controls  
and Indicator Lights (Sheet 1 of 2)

1. **OFF/VOLUME CONTROL** - The small, inner control turns the set on or off and adjusts the audio listening level. Clockwise rotation turns the set on and increases the audio level.
2. **DIM/BRT CONTROL** - The large, outer control provides light dimming for the marker lights. Clockwise rotation increases light intensity.
3. **TEST SWITCH** - (150, 182, 206, 207, 210 & 337 Model Series Only) When the press-to-test switch button is depressed, the marker beacon lights will illuminate, indicating the lights are operational (the test position is a lamp test function only).

**NOTE**

Turn the set on, and rotate the DIM control clockwise (fully on) in order to view the marker beacon lights during test.

4. **LO/HI SENS SWITCH** - (150, 182, 206, 207, 210 & 337 Model Series Only) In the LO position (Up), receiver sensitivity is positioned for ILS approaches. In the HI position (Down), receiver sensitivity is positioned for airway flying.
5. **SPEAKER/PHONE SWITCH** - Selects speaker or phone for aural reception.
6. **MARKER BEACON INDICATOR LIGHTS** - Indicates passage of outer, middle and inner marker beacons. The OUTER light is blue, the MIDDLE light is amber and the INNER light is white.
7. **HI/LO/TEST SWITCH** - (172, 177, 177RG, 180 & 185 Model Series Only) In the HI position (Up), receiver sensitivity is positioned for airway flying. In the LO position (Center), receiver sensitivity is positioned for ILS approaches. In the TEST position (Down), the marker lights will illuminate, indicating the lights are operational (the test position is a lamp test function only).

**NOTE**

Turn the set on, and rotate the BRIGHT control clockwise (fully on) in order to view the marker beacon lights during test. The TEST position on the switch is spring loaded to return the switch to the LO SENS position when TEST position is released.

Figure 1. Cessna 400 Marker Beacon Operating Controls and Indicator Lights (Sheet 2 of 2)

## SECTION 2 LIMITATIONS

There is no change to the airplane limitations when this avionic equipment is installed.

## SECTION 3 EMERGENCY PROCEDURES

There is no change to the airplane emergency procedures when this avionic equipment is installed.

## SECTION 4 NORMAL PROCEDURES

TO OPERATE:

- (1) OFF/VOL Control -- VOL position and adjust to desired listening level.
- (2) LO/HI SENS Switch -- SELECT HI position for airway flying or LO position for ILS approaches.
- (3) SPKR/PHONE Switch -- SELECT speaker or phone audio.
- (4) TEST Switch -- PRESS and ensure that marker beacon indicator lights are operative.

### NOTE

Ensure that BRT control is on enough to view the marker beacon.

## SECTION 5 PERFORMANCE

There is no change to the airplane performance when this avionic equipment is installed. However, the installation of an externally mounted antenna or several related external antennas, will result in a minor reduction in cruise performance.



**SUPPLEMENT**

**CESSNA 400 TRANSPONDER**  
(Type RT-459A)  
**AND**  
**OPTIONAL ALTITUDE ENCODER**  
(Type EA-401A)

**SECTION 1**  
**GENERAL**

The Cessna 400 Transponder (Type 459A), shown in Figure 1, is the airborne component of an Air Traffic Control Radar Beacon System (ATCRBS). The transponder enables the ATC ground controller to "see" and identify the aircraft, while in flight, at distances beyond the primary radar range.

The 400 Transponder consists of a panel-mounted unit and an externally-mounted antenna. The transponder receives interrogating pulse signals on 1030 MHz and transmits coded pulse-train reply signals on 1090 MHz. It is capable of replying to Mode A (aircraft position identification) and Mode C (altitude information) interrogations on a selective reply basis on any of 4,096 information code selections. When an optional panel mounted EA-401A altitude encoder (not part of 400 Transponder System) is included in the avionic configuration, the transponder can provide altitude reporting in 100-foot increments between -1000 and +35,000 feet.

All Cessna 400 Transponder operating controls are located on the front panel of the unit. The optional altitude encoder's barometric pressure set knob is located on the altitude encoder. Function of the operating controls is described in Figure 1.

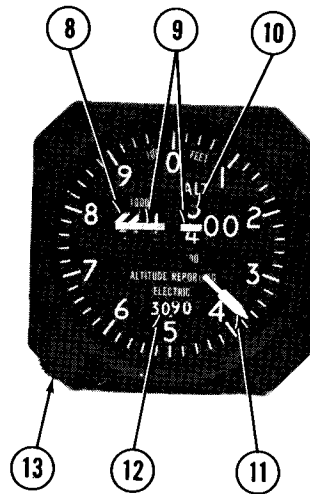
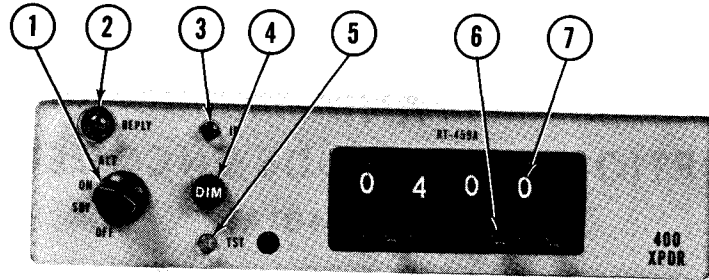

Figure 1. Cessna 400 Transponder and Altitude Encoder  
Operating Controls (Sheet 1 of 2)

1. **FUNCTION SWITCH** - Controls application of power and selects Transponder operating mode, as follows:
  - OFF - Removes power from transponder (turns set off).
  - SBY - Applies power for equipment warm-up.
  - ON - Applies operating power and enables transponder to transmit Mode A reply pulses.
  - ALT - Applies operating power and enables transponder to transmit either Mode A reply pulses or Mode C altitude information pulses selected automatically by the interrogating signal.
2. **REPLY LAMP** - Provides visual indication of transponder replies. During normal operation, lamp flashes when reply pulses are transmitted; when special pulse identifier is selected, lamp glows steadily for duration of IDENT pulse transmission. (Reply Lamp will also glow steadily during initial warm-up period.)
3. **IDENT SWITCH** - When depressed, selects special pulse identifier to be transmitted with transponder reply to effect immediate identification of aircraft on ground controller's display. (Reply Lamp will glow steadily during duration of IDENT pulse transmission.)
4. **DIMMER CONTROL** - Allows pilot to control brilliance of Reply Lamp.
5. **SELF-TEST SWITCH** - When depressed, causes transponder to generate a self-interrogating signal to provide a check of transponder operation. (Reply Lamp will illuminate to verify self test operation.)
6. **REPLY-CODE SELECTOR SWITCHES (4)** - Select assigned Mode A (or Mode C) Reply Code.
7. **REPLY-CODE INDICATORS (4)** - Display selected Mode A (or Mode C) Reply Code.
8. **1000-FOOT DRUM TYPE INDICATOR** - Provides digital altitude readout in 1000-foot increments between -1000 feet and +35,000 feet.
9. **OFF INDICATOR WARNING FLAG** - Flag appears when power is removed from the system.
10. **100-FOOT DRUM TYPE INDICATOR** - Provides digital altitude readout in 100-foot increments between 0 feet and 1000 feet.
11. **20-FOOT INDICATOR NEEDLE** - Indicates altitude in 20-foot increments between 0 feet and 1000 feet.
12. **BAROMETRIC PRESSURE SET INDICATOR - DRUM TYPE** - Indicates selected barometric pressure in the range of 27.9 to 31.0 inches of mercury.
13. **BAROMETRIC PRESSURE SET KNOB** - Dials in desired barometric pressure setting in the range of 27.9 to 31.0 inches of mercury.

Figure 1. Cessna 400 Transponder and Altitude Encoder  
Operating Controls (Sheet 2 of 2)

## SECTION 2 LIMITATIONS

There is no change to the airplane limitations when this avionic equipment is installed.

## SECTION 3 EMERGENCY PROCEDURES

TO TRANSMIT AN EMERGENCY SIGNAL:

- (1) Function Switch -- ON.
- (2) Reply-Code Selector Switches -- SELECT 7700 operating code.
- (3) ID Switch -- DEPRESS to effect immediate identification of aircraft on ground controller's display.
- (4) DIM Control -- ADJUST light brilliance of reply lamp.

TO TRANSMIT A SIGNAL REPRESENTING LOSS OF ALL COMMUNICATIONS:

- (1) Function Switch -- ON.
- (2) Reply-Code Selector Switches -- SELECT 7700 operating code for 1 minute, then select 7600 operating code for 15 minutes and then repeat this procedure for remainder of flight.
- (3) ID Switch -- DEPRESS to effect immediate identification of aircraft on ground controller's display.
- (4) DIM Control -- ADJUST light brilliance of reply lamp.

## SECTION 4 NORMAL PROCEDURES

BEFORE TAKEOFF AND WHILE TAXIING:

- (1) Function Switch -- SBY.

TO TRANSMIT MODE A (AIRCRAFT POSITION IDENTIFICATION) CODES IN FLIGHT:

- (1) Reply-Code Selector Switches -- SELECT assigned code.

- (2) Function Switch -- ON.
- (3) DIM Control -- ADJUST light brilliance of reply lamp.

NOTE

During normal operation with function switch in ON position, REPLY lamp flashes indicating transponder replies to interrogations.

- (4) ID Button -- DEPRESS momentarily when instructed by ground controller to "squawk IDENT" (REPLY lamp will glow steadily, indicating IDENT operation).

TO TRANSMIT MODE C (ALTITUDE INFORMATION) CODES IN FLIGHT:

- (1) Altitude Encoder Barometric Pressure Set Knob -- DIAL assigned barometric pressure.
- (2) Reply-Code Selector Switches -- SELECT assigned code.
- (3) Function Switch -- ALT.

NOTE

When directed by ground controller to "stop altitude squawk", turn Function Switch to ON for Mode A operation only.

NOTE

Pressure altitude is transmitted, and conversion to indicated altitude is done in ATC computers. Altitude squawk will agree with indicated altitude when altimeter setting in use by the ground controller is set in the altitude encoder.

- (4) DIM Control -- ADJUST light brilliance of reply lamp.

TO SELF-TEST TRANSPONDER OPERATION:

- (1) Function Switch -- SBY and wait 30 seconds for equipment to warm-up.
- (2) Function Switch -- ON.
- (3) TST Button -- DEPRESS (Reply lamp should light brightly regardless of DIM control setting).

## **SECTION 5**

### **PERFORMANCE**

There is no change to the airplane performance when this avionic equipment is installed. However, the installation of an externally mounted antenna or several related external antennas, will result in a minor reduction in cruise performance.

# SUPPLEMENT

## CESSNA NAVOMATIC 200A AUTOPILOT

(Type AF-295B)

### SECTION 1

#### GENERAL

The Cessna 200A Navomatic is an all electric, single-axis (aileron control) autopilot system that provides added lateral and directional stability. Components are a computer-amplifier, a turn coordinator, an aileron actuator, and a course deviation indicator(s) incorporating a localizer reversed (BC) indicator light.

Roll and yaw motions of the airplane are sensed by the turn coordinator gyro. The computer-amplifier electronically computes the necessary correction and signals the actuator to move the ailerons to maintain the airplane in the commanded lateral attitude.

The 200A Navomatic will also capture and track a VOR or localizer course using signals from a VHF navigation receiver.

The operating controls for the Cessna 200A Navomatic are located on the front panel of the computer-amplifier, shown in Figure 1. The primary function pushbuttons (DIR HOLD, NAV CAPT, and NAV TRK), are interlocked so that only one function can be selected at a time. The HI SENS and BACK CRS pushbuttons are not interlocked so that either or both of these functions can be selected at any time.

### SECTION 2

#### LIMITATIONS

There is no change to the airplane limitations when this avionic equipment is installed. However, the following autopilot limitations should be adhered to during airplane operation:

BEFORE TAKE-OFF AND LANDING:

- (1) A/P ON-OFF Switch -- OFF.

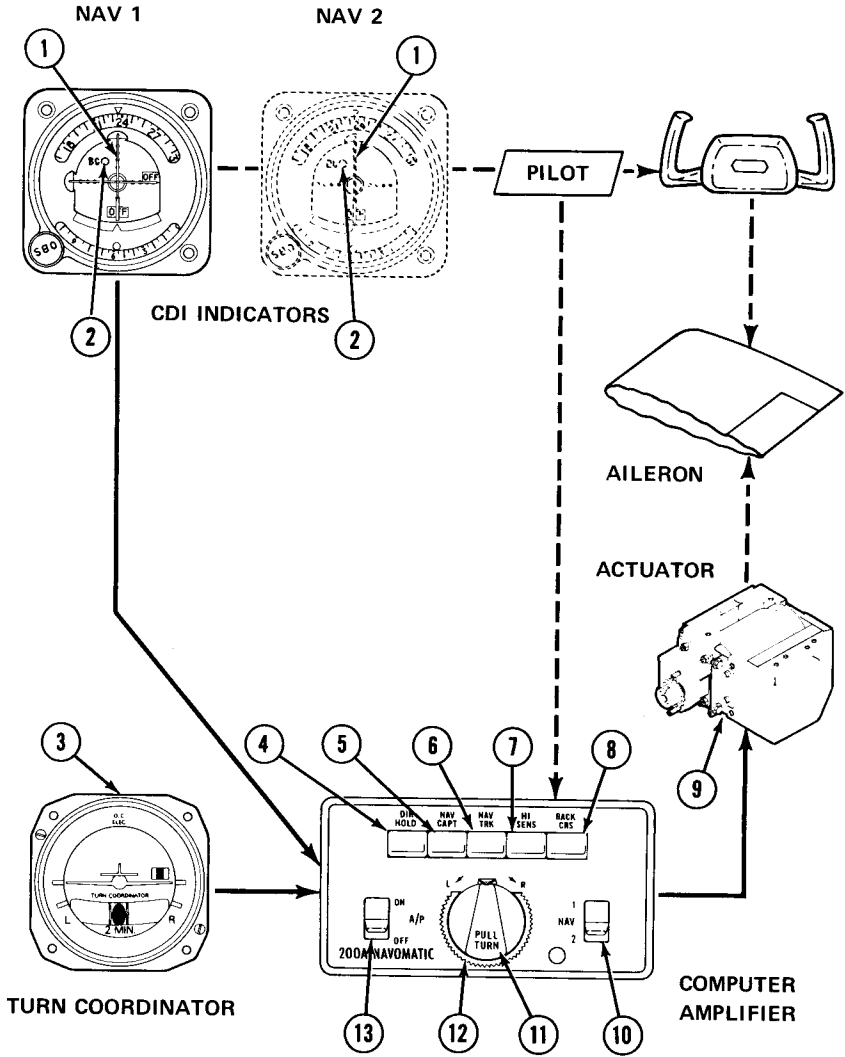

Figure 1. Cessna 200A Autopilot, Operating Controls and Indicators  
(Sheet 1 of 2)



1. COURSE DEVIATION INDICATOR - Provides VOR/LOC navigation inputs to autopilot for intercept and tracking modes.
2. LOCALIZER REVERSED INDICATOR LIGHT - Amber light, labeled BC, illuminates when BACK CRS button is pushed in (engaged) and LOC frequency selected. BC light indicates course indicator needle is reversed on selected receiver (when tuned to a localizer frequency). This light is located within the CDI indicator.
3. TURN COORDINATOR - Senses roll and yaw for wings leveling and command turn functions.
4. DIR HOLD - Airplane holds direction it is flying at time button is pushed.
5. NAV CAPT - Airplane will turn to and capture selected VOR or LOC course.
6. NAV TRK - Airplane tracks selected VOR or LOC course.
7. HI SENS - During NAV CAPT or NAV TRK operation, this high sensitivity setting increases autopilot response to NAV signal to provide more precise operation during localizer approach. In low sensitivity position (pushbutton out), response to NAV signal is dampened for smoother tracking of enroute VOR radials; it also smooths out effect of course scalloping during NAV operation.
8. BACK CRS - Used with LOC operation only. With A/P switch OFF or ON, and when navigation receiver selected by NAV switch is set to a localizer frequency, it reverses normal localizer needle indication (CDI) and causes localizer reversed (BC) light to illuminate. With A/P switch ON, reverses localizer signal to autopilot.
9. ACTUATOR - The torque motor in the actuator causes the ailerons to move in the desired direction.
10. NAV - Selects NAV 1 or NAV 2 navigation receiver.
11. PULL TURN - When pulled out and centered in detent, airplane will fly wings-level; when turned to the right (R), the airplane will execute a right, standard rate turn; when turned to the left (L), the airplane will execute a left, standard rate turn. When centered in detent and pushed in, the operating mode selected by a push button is engaged.
12. TRIM - Used to trim autopilot to compensate for minor variations in aircraft trim or weight distribution. (For proper operation, the aircraft's rudder trim must be manually trimmed before the autopilot is engaged.)
13. A/P - Turns autopilot ON or OFF.

Figure 1. Cessna 200A Autopilot, Operating Controls and Indicators  
(Sheet 2 of 2)

- (2) BACK CRS Button -- DISENGAGED (OUT). (Refer to Section 4 of this supplement and see Step 6 and Caution note under "NAV CAPTURE (VOR/LOC)".)

NAV CAPTURE (VOR/LOC):

- (1) Fly a manual intercept procedure if more than 15 miles from the station or more than 3 minutes from intercept.

### SECTION 3 EMERGENCY PROCEDURES

TO OVERRIDE THE AUTOPILOT:

- (1) Airplane control Wheel -- ROTATE as required to override autopilot.

NOTE

The servo may be overpowered at anytime without damage.

TO TURN OFF AUTOPILOT:

- (1) A/P ON-OFF Switch -- OFF.

### SECTION 4 NORMAL PROCEDURES

BEFORE TAKE-OFF AND LANDING:

- (1) A/P ON-OFF Switch -- OFF.
- (2) BACK CRS Button -- OFF (see Caution note under Nav Capture).

NOTE

Periodically verify operation of amber warning light(s), labeled BC on CDI(s), by engaging BACK CRS button with a LOC frequency selected.

INFLIGHT WINGS LEVELING:

- (1) Airplane Trim -- ADJUST.
- (2) PULL-TURN Knob -- PULL out and center in detent.
- (3) A/P ON-OFF Switch -- ON.
- (4) Autopilot TRIM Control -- ADJUST for zero turn rate.

COMMAND TURNS:

- (1) PULL-TURN Knob -- PULL and ROTATE.

DIRECTION HOLD:

- (1) PULL-TURN Knob -- PULL out and center in detent.
- (2) DIR HOLD Button -- PUSH.
- (3) PULL-TURN Knob -- PUSH in detent position.
- (4) Autopilot TRIM Control -- READJUST to minimize heading drift.

NAV CAPTURE (VOR/LOC):

- (1) PULL-TURN Knob -- PULL out.
- (2) NAV 1-2 Selector Switch -- SELECT desired VOR receiver.
- (3) Nav Receiver OBS -- SET VOR course (if tracking omni).
- (4) NAV CAPT Button -- PUSH.
- (5) HI SENS Button -- PUSH.
- (6) BACK CRS Button -- PUSH only if intercepting localizer front course outbound or back course inbound.

**CAUTION**

With BACK CRS button pushed in and localizer frequency selected, the CDI on selected nav radio will be reversed even when the autopilot switch is OFF.

- (7) PULL-TURN Knob -- TURN airplane parallel to course. Then PUSH for automatic intercept. If more than 15 miles from the station or more than 3 minutes from intercept, use a manual intercept procedure.
- (8) NAV TRK Button -- PUSH when CDI centers and airplane is within  $\pm 5^\circ$  of course heading.
- (9) HI SENS Button -- DISENGAGE for omni tracking (leave ENGAGED for localizer).

NAV TRACKING (VOR/LOC):

- (1) PULL-TURN Knob -- PULL out.

- (2) NAV 1-2 Selector Switch -- SELECT desired VOR receiver.
- (3) Nav Receiver OBS -- SET VOR course (if tracking omni).
- (4) NAV TRK Button -- PUSH.
- (5) HI SENS Button -- PUSH for localizer; disengage for omni.
- (6) BACK CRS Button -- PUSH only if tracking localizer front course outbound or back course inbound.

**CAUTION**

See caution paragraph under Nav Capture.

- (7) PULL-TURN Knob -- PUSH when airplane is on course and on heading.
- (8) Autopilot TRIM Control -- READJUST as required to maintain track.

## SECTION 5 PERFORMANCE

There is no change to the airplane performance when this avionic equipment is installed.

## **SUPPLEMENT**

# **CESSNA NAVOMATIC 300A AUTOPILOT** **(Type AF-395A)**

### **SECTION 1**

#### **GENERAL**

The Cessna 300A Navomatic is an all electric, single-axis (aileron control) autopilot system that provides added lateral and directional stability. Components are a computer-amplifier, a turn coordinator, a directional gyro, an aileron actuator and a course deviation indicator(s) incorporating a localized reversed (BC) indicator light.

Roll and yaw motions of the airplane are sensed by the turn coordinator gyro. Deviations from the selected heading are sensed by the directional gyro. The computer-amplifier electronically computes the necessary correction and signals the actuator to move the ailerons to maintain the airplane in the commanded lateral attitude or heading.

The 300A Navomatic will also intercept and track a VOR or localizer course using signals from a VHF navigation receiver.

The operating controls for the Cessna 300A Navomatic are located on the front panel of the computer-amplifier and on the directional gyro, shown in Figure 1. The primary function pushbuttons (HDG SEL, NAV INT, and NAV TRK), are interlocked so that only one function can be selected at a time. The HI SENS and BACK CRS pushbuttons are not interlocked so that either or both of these functions can be selected at any time.

### **SECTION 2**

#### **LIMITATIONS**

There is no change to the airplane limitations when this avionic equip-

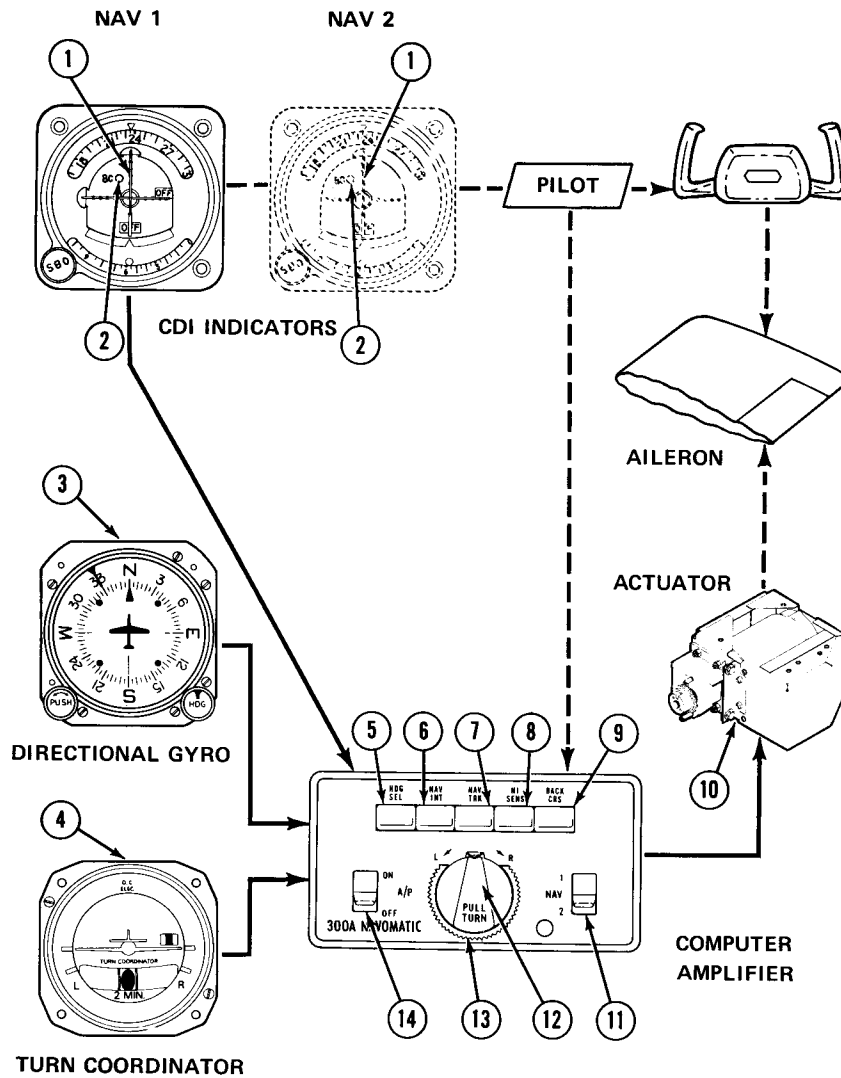

Figure 1. Cessna 300A Autopilot, Operating Controls and Indicators  
(Sheet 1 of 2)

1. COURSE DEVIATION INDICATOR - Provides VOR/LOC navigation inputs to autopilot for intercept and tracking modes.
2. LOCALIZER REVERSED INDICATOR LIGHT - Amber light, labeled BC, illuminates when BACK CRS button is pushed in (engaged) and LOC frequency selected. BC light indicates course indicator needle is reversed on selected receiver (when tuned to a localizer frequency). This light is located within the CDI indicator.
3. DIRECTIONAL GYRO INDICATOR - Provides heading information to the autopilot for heading intercept and hold.
4. TURN COORDINATOR - Senses roll and yaw for wings leveling and command turn functions.
5. HDG SEL - Aircraft will turn to and hold heading selected by the heading "bug" on the directional gyro.
6. NAV INT - When heading "bug" on DG is set to selected course, aircraft will turn to and intercept selected VOR or LOC course.
7. NAV TRK - When heading "bug" on DG is set to selected course, aircraft will track selected VOR or LOC course.
8. HI SENS - During NAV INT or NAV TRK operation, this high sensitivity setting increases autopilot response to NAV signal to provide more precise operation during localizer approach. In low-sensitivity position (pushbutton out), response to NAV signal is dampened for smoother tracking of enroute VOR radials; it also smooths out effect of course scalloping during NAV operation.
9. BACK CRS - Used with LOC operation only. With A/P switch OFF or ON, and when navigation receiver selected by NAV switch is set to a localizer frequency, it reverses normal localizer needle indication (CDI) and causes localizer reversed (BC) light to illuminate. With A/P switch ON, reverses localizer signal to autopilot.
10. ACTUATOR - The torque motor in the actuator causes the ailerons to move in the desired direction.
11. NAV - Selects NAV 1 or NAV 2 navigation receiver.
12. PULL TURN - When pulled out and centered in detent, airplane will fly wings-level; when turned to the right (R), the airplane will execute a right, standard rate turn; when turned to the left (L), the airplane will execute a left, standard rate turn. When centered in detent and pushed in, the operating mode selected by a push button is engaged.
13. TRIM - Used to trim autopilot to compensate for minor variations in aircraft trim or lateral weight distribution. (For proper operation, the aircraft's rudder trim must be manually trimmed before the autopilot is engaged.)
14. A/P - Controls primary power to autopilot servo (turns autopilot ON or OFF).

Figure 1. Cessna 300A Autopilot, Operating Controls and Indicators  
(Sheet 2 of 2)

ment is installed. However, the following autopilot limitations should be adhered to during airplane operation:

**BEFORE TAKE-OFF AND LANDING:**

- (1) A/P ON-OFF Switch -- OFF.
- (2) BACK CRS Button -- DISENGAGED (OUT). (Refer to Section 4 of this supplement and see Step 8 and Caution note under "NAV INTERCEPT (VOR/LOC)".)

### **SECTION 3 EMERGENCY PROCEDURES**

**TO OVERRIDE THE AUTOPILOT:**

- (1) Airplane Control Wheel -- ROTATE as required to override autopilot.

**NOTE**

The servo may be overpowered at any time without damage.

**TO TURN OFF AUTOPILOT:**

- (1) A/P ON-OFF Switch -- OFF.

### **SECTION 4 NORMAL PROCEDURES**

**BEFORE TAKE-OFF AND LANDING:**

- (1) A/P ON-OFF Switch -- OFF.
- (2) BACK CRS Button -- OFF (see caution note under Nav Intercept).

**NOTE**

Periodically verify operation of amber warning light(s), labeled BC on CDI(s), by engaging BACK CRS button with a LOC frequency selected.

**INFLIGHT WINGS LEVELING:**

- (1) Airplane Trim -- ADJUST.



- (2) PULL-TURN Knob -- PULL out and center in detent.
- (3) A/P ON-OFF Switch -- ON.
- (4) Autopilot TRIM Control -- ADJUST for zero turn rate.

HEADING SELECT:

- (1) Directional Gyro -- SET to airplane magnetic heading.
- (2) Heading Selector Knob -- ROTATE bug to desired heading.
- (3) Heading Select Button -- PUSH.
- (4) PULL-TURN Knob -- PUSH.

NOTE

Airplane will return automatically to selected heading.  
If airplane fails to hold the precise heading, readjust  
autopilot lateral TRIM knob as required or disengage  
autopilot and reset manual trim.

NAV INTERCEPT (VOR/LOC):

- (1) PULL-TURN Knob -- PULL out.
- (2) NAV 1-2 Selector Switch -- SELECT.
- (3) Nav Receiver OBS -- SET VOR course (if tracking omni).
- (4) Heading Selector Knob -- ROTATE bug to selected course (VOR or localizer).
- (5) Directional Gyro -- SET for magnetic heading.
- (6) NAV INT Button -- PUSH.
- (7) HI SENS Button -- PUSH for localizer and "close-in" omni intercepts.
- (8) BACK CRS Button -- PUSH only if intercepting localizer front course outbound or back course inbound.

**CAUTION**

With BACK CRS button pushed in and localizer frequency selected, the CDI on selected nav radio will be reversed even when the autopilot switch is OFF.

- (9) PULL-TURN Knob -- PUSH.

NOTE

Airplane will automatically turn to a 45° intercept angle.

- (10) NAV TRK Button -- PUSH when CDI centers (within one dot) and airplane is within  $\pm 10^\circ$  of course heading.

- (11) HI SENS Button -- Disengage for omni tracking (leave engaged for localizer).

NAV TRACKING (VOR/LOC):

- (1) PULL-TURN Knob -- PULL out.
- (2) NAV 1-2 Selector Switch -- SELECT desired VOR receiver.
- (3) Nav Receiver OBS -- SET VOR course (if tracking omni).
- (4) Heading Selector Knob -- ROTATE bug to selected course (VOR or localizer).
- (5) Directional Gyro -- SET for magnetic heading.
- (6) NAV TRK Button -- PUSH.
- (7) HI SENS Button -- PUSH for localizer; disengage for omni.
- (8) BACK CRS Button -- PUSH only if tracking localizer front course outbound or back course inbound.

**CAUTION**

See caution paragraph under Nav Intercept.

- (9) PULL-TURN Knob -- PUSH when CDI is within 1 dot and airplane is within  $\pm 10^\circ$  of course heading.

NOTE

If CDI remains steadily off center, readjust autopilot lateral trim control as required.

## SECTION 5 PERFORMANCE

There is no change to the airplane performance when this avionic equipment is installed.